

DrayTek

VigorAP 918R Series

802.11ac Outdoor AP



USER'S GUIDE

V1.0

VigorAP 918R

802.11ac Outdoor AP

User's Guide

Version: 1.0

Firmware Version: V1.3.0

Date: February 5, 2020

Intellectual Property Rights (IPR) Information

Copyrights

© All rights reserved. This publication contains information that is protected by copyright. No part may be reproduced, transmitted, transcribed, stored in a retrieval system, or translated into any language without written permission from the copyright holders.

Trademarks

The following trademarks are used in this document:

- Microsoft is a registered trademark of Microsoft Corp.
- Windows, Windows 95, 98, Me, NT, 2000, XP, Vista, 7 and Explorer are trademarks of Microsoft Corp.
- Apple and Mac OS are registered trademarks of Apple Inc.
- Other products may be trademarks or registered trademarks of their respective manufacturers.

Safety Instructions and Approval

Safety Instructions

- Read the installation guide thoroughly before you set up the modem.
- The modem is a complicated electronic unit that may be repaired only be authorized and qualified personnel. Do not try to open or repair the modem yourself.
- Do not place the modem in a damp or humid place, e.g. a bathroom.
- The modem should be used in a sheltered area, within a temperature range of +5 to +40 Celsius.
- Do not expose the modem to direct sunlight or other heat sources. The housing and electronic components may be damaged by direct sunlight or heat sources.
- Do not deploy the cable for LAN connection outdoor to prevent electronic shock hazards.
- Keep the package out of reach of children.
- When you want to dispose of the modem, please follow local regulations on conservation of the environment.

Warranty

We warrant to the original end user (purchaser) that the modem will be free from any defects in workmanship or materials for a period of one (1) year from the date of purchase from the dealer. Please keep your purchase receipt in a safe place as it serves as proof of date of purchase. During the warranty period, and upon proof of purchase, should the product have indications of failure due to faulty workmanship and/or materials, we will, at our discretion, repair or replace the defective products or components, without charge for either parts or labor, to whatever extent we deem necessary to restore the product to proper operating condition. Any replacement will consist of a new or re-manufactured functionally equivalent product of equal value, and will be offered solely at our discretion. This warranty will not apply if the product is modified, misused, tampered with, damaged by an act of God, or subjected to abnormal working conditions. The warranty does not cover the bundled or licensed software of other vendors. Defects which do not significantly affect the usability of the product will not be covered by the warranty. We reserve the right to revise the manual and online documentation and to make changes from time to time in the contents hereof without obligation to notify any person of such revision or changes.

Be a Registered Owner

Web registration is preferred. You can register your Vigor modem via <http://www.draytek.com>.

Firmware & Tools Updates

Due to the continuous evolution of DrayTek technology, all modems will be regularly upgraded. Please consult the DrayTek web site for more information on newest firmware, tools and documents. <http://www.draytek.com>

Table of Contents

Chapter I Installation	VII
I-1 Introduction	1
I-1-1 LED Indicators and Connectors	2
I-2 Mounting the Access Point	3
I-2-1 Antennas Installation	3
I-2-2 Connecting Ethernet Cable(s)	4
I-2-3 Pole Mount Installation – for VigorAP 918RPD	6
I-2-4 Pole Mount Installation – for VigorAP 918R	8
I-2-5 Wall Mount Installation – for VigorAP 918R	9
I-2-6 Grounding Access Point	10
I-2-7 Powering Access Point	11
I-3 Network IP Configuration	12
I-3-1 Windows 10 IP Address Setup	12
I-4 Accessing to Web User Interface	15
I-5 Changing Password	18
I-6 Dashboard	19
I-7 Quick Start Wizard	20
I-7-1 Settings for Access Point	21
I-7-2 Settings for Mesh Root	24
I-7-3 Settings for Mesh Node	29
I-7-4 Settings for Range Extender	30
Chapter II Connectivity	35
II-1 Operation Mode	36
II-2 General Concepts for Wireless LAN (2.4GHz/5GHz)	38
II-3 Wireless LAN (2.4GHz/5GHz) Settings for AP Mode	41
II-3-1 General Setup	42
II-3-2 Security	45
II-3-3 Access Control	48
II-3-4 WPS	49
II-3-5 Advanced Setting	50
II-3-6 AP Discovery	53
II-3-7 WDS AP Status	54
II-3-8 Bandwidth Management	54
II-3-9 Airtime Fairness	55
II-3-10 Station Control	57
II-3-11 Roaming	59
II-3-12 Band Steering (for Wireless LAN (2.4GHz))	61
II-3-13 Station List	66
II-4 Mesh Settings for Mesh Mode	72
II-4-1 Mesh Setup	74
II-4-2 Mesh Status	79
II-4-3 Mesh Discovery	80
II-4-4 Basic Configuration Sync	81
II-4-5 Advanced Config Sync	84
II-5 Universal Repeater Settings for Range Extender Mode	85
II-6 LAN	89
II-6-1 General Setup	89
II-6-2 Web Portal	92

Chapter III Management	95
III-1 System Maintenance.....	96
III-1-1 System Status	97
III-1-2 TR-069.....	98
III-1-3 Administrator Password	100
III-1-4 User Password.....	101
III-1-5 Configuration Backup.....	102
III-1-6 Syslog/Mail Alert.....	104
III-1-7 Time and Date	105
III-1-8 SNMP.....	106
III-1-9 Management.....	107
III-1-10 Reboot System	109
III-1-11 Firmware Upgrade.....	110
III-2 Central AP Management.....	111
III-2-1 General Setup	111
III-2-2 APM Log.....	112
III-2-3 Overload Management	113
III-2-4 Status of Settings.....	114
III-3 Mobile Device Management	115
III-3-1 Station List.....	115
III-3-2 Station Statistics	121
III-3-3 Station Nearby.....	122
III-3-4 Policies	123
III-3-5 Station Control List	124
Chapter IV Others	125
IV-1 RADIUS Setting.....	126
IV-1-1 RADIUS Server	126
IV-1-2 Certificate Management	127
IV-2 Applications.....	130
IV-2-1 Schedule	130
IV-2-2 Apple iOS Keep Alive.....	132
IV-2-3 Wi-Fi Auto On/Off.....	134
IV-2-4 Sensor	135
IV-3 Objects Setting.....	137
IV-3-1 Device Object.....	137
IV-3-3 Device Group	139
Chapter V Mobile APP, DrayTek Wireless.....	141
V-1 Introduction of DrayTek Wireless.....	142
V-2 Select a VigorAP	143
V-3 Quick Start Wizard.....	144
V-4 Login.....	153
Chapter VI Troubleshooting.....	157
V-1 Diagnostics	158
V-1-1 System Log.....	159
V-1-2 Speed Test.....	159
V-1-3 Traffic Graph	160
V-1-4 WLAN (2.4GHz) Statistics.....	161
V-1-5 WLAN (5GHz) Statistics	162
V-1-6 Interference Monitor	163
V-1-7 Support Area.....	164
V-2 Checking the Hardware Status	165

V-3 Checking the Network Connection Settings	166
V-3-1 For Windows	166
V-3-2 For Mac Os	168
V-4 Pinging the Device	169
V-4-1 For Windows	169
V-4-2 For Mac Os (Terminal)	169
V-5 Backing to Factory Default Setting	171
V-5-1 Software Reset.....	171
V-5-2 Hardware Reset.....	172
V-6 Contacting DrayTek	173
Index	174

Chapter I Installation

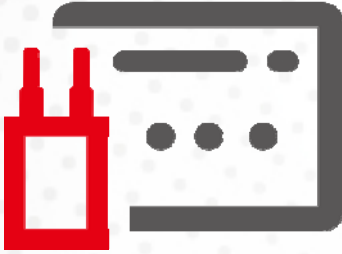

I-1 Introduction

This is a generic International version of the user guide. Specification, compatibility and features vary by region. For specific user guides suitable for your region or product, please contact local distributor.

Thank you for purchasing VigorAP 918R series.

Easy install procedures allows any computer users to setup a network environment in very short time - within minutes, even inexperienced users. Just follow the instructions given in this user manual, you can complete the setup procedure and release the power of this access point all by yourself!



VigorAP 918RPD also is a Power over Ethernet Powered Device which adopts the technology of PoE for offering power supply and transmitting data through the Ethernet cable.

I-1-1 LED Indicators and Connectors

Before you use the Vigor modem, please get acquainted with the LED indicators and connectors first.

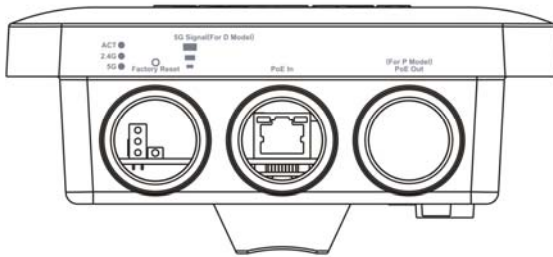

AP918R

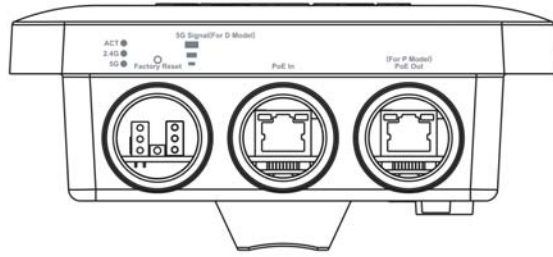

AP918RPD

LED	Status	Explanation
ACT	Off	The system is not ready or has failed.
	Blinking	The system is ready.
2.4G / 5G	On	Wireless function is ready.
	Off	Wireless function is not ready.
	Blinking	Data is being transmitted (sending/receiving).
5G Signal (For D Model)		The signal strength (excellent) > -50dBm.
5G Signal (For D Model)		The signal strength (good) is between -66dBm ~ -51dBm.
5G Signal (For D Model)		The signal strength (fair) is between -73dBm~ -67dBm.
5G Signal (For D Model)		No signal or the signal strength is <-73dBm.
Interface	Description	
Factory Reset	Restore the default settings. Usage: Switch on the access point. Press and hold reset button for at least 10 seconds. The router will restart with the factory default configuration. Before pressing the button, the cover should first be removed by rotating it with a torque of 13 kgf-cm. After the access point has been reset, replace the cover and lock it with the same amount of torque.	
PoE In	Connector for receiving power from another device.	
PoE Out (For D Model)	Connector for supplying power to another device.	

i Note:

For the sake of security, make the accessory kit away from children.

I-2 Mounting the Access Point

The VigorAP can be pole mounted depending on the installation environment. This section will guide you through installing the VigorAP.

i Note:

For the sake of personal safety, only trained and qualified personnel should install this device.

I-2-1 Antennas Installation

1. Remove the protective cap.

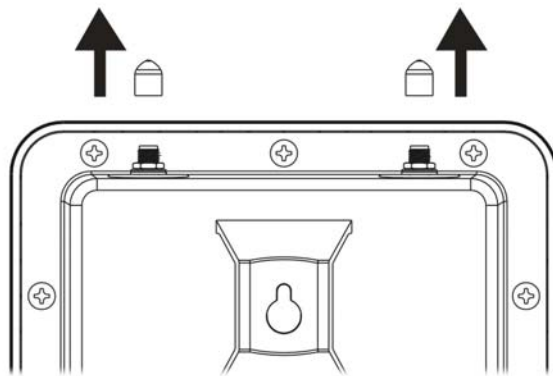

2. Insert the antennas and fasten them by rotating clockwise.

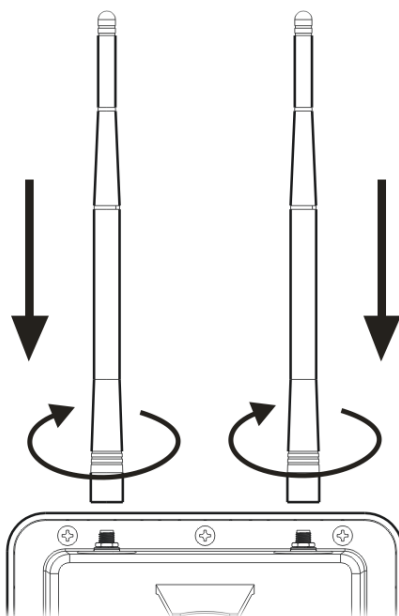

i Warning:

Do not open the top cover of the device.

Installation during thunderstorms could be dangerous.

I-2-2 Connecting Ethernet Cable(s)

Refer to the following steps to attach the Ethernet cable and waterproof head. (Take VigorAP 918RPD as an example.)

1. Remove the cable cover for Ethernet Port (e.g., **Port 1 PoE In**).
2. Before connecting, verify that the cable has a rubber seal and that it is not damaged.
To prevent the enclosure from water leakage, make sure the Ethernet cable gland and the rubber gasket are present and installed properly.
3. Inserting RJ-45 connector into the port.

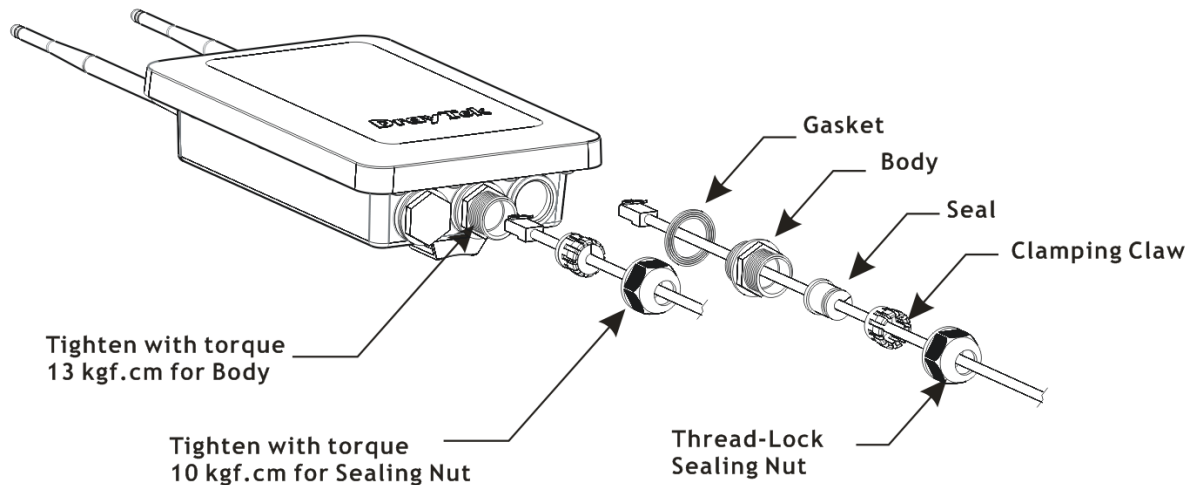

4. Use an adjustable wrench and tighten the thread-lock sealing nut with torque 10 kgf-cm.
-

i Note:

Do not pull the cable backwards; the force might break the plug.

Reconnecting Ethernet Cable

1. Loosen the thread-lock sealing nut.
2. Loosen the clamping claw and seal.
3. Loosen the body and washer.
4. Remove the cable.

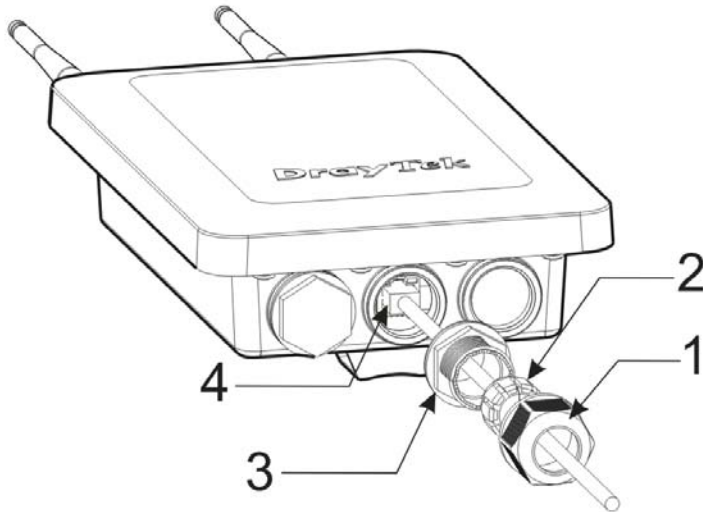

5. To reattach the cable, follow the above steps in reverse.

i Note:

The diameter for the Ethernet cable shall be limited between 4.3mm to 5.9mm.

I-2-3 Pole Mount Installation – for VigorAP 918RPD

1. Find a suitable location for installing the access point.
2. Select a mounting point on a pole.
3. Attach the mount kit assembly to the mounting plate by locking four screws with the torque of 10 kgf-cm.

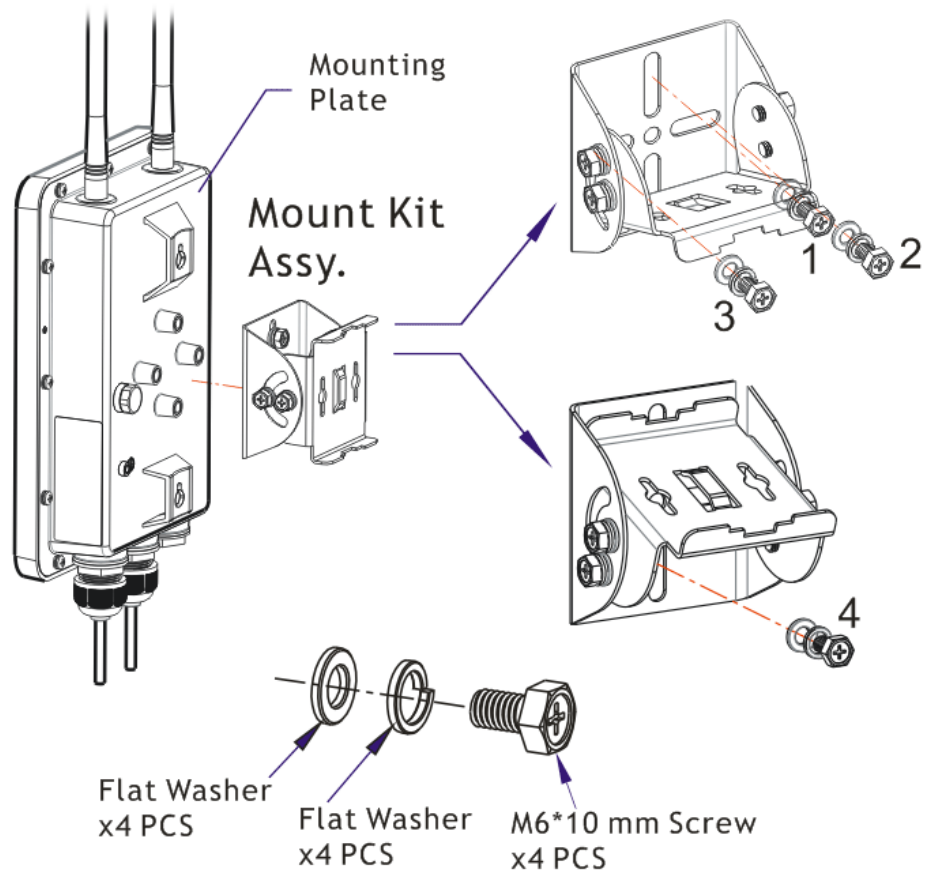

4. Insert the pipe clamp into the mount kit assembly.

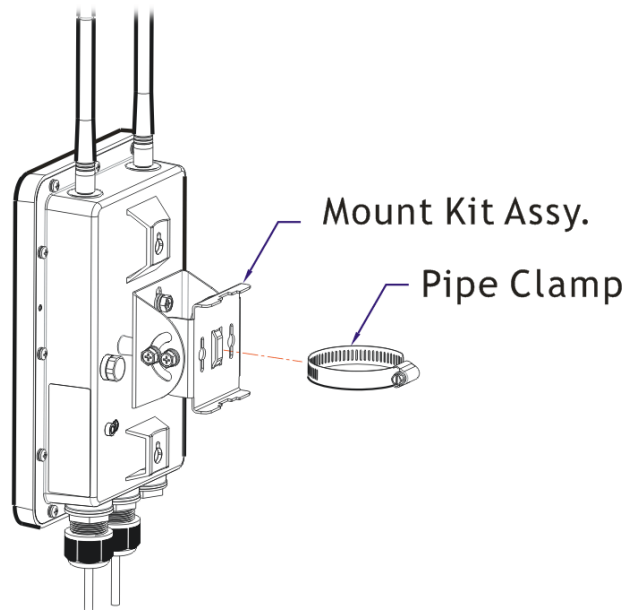

5. Press the pipe clamp to open it for clamping the pole.

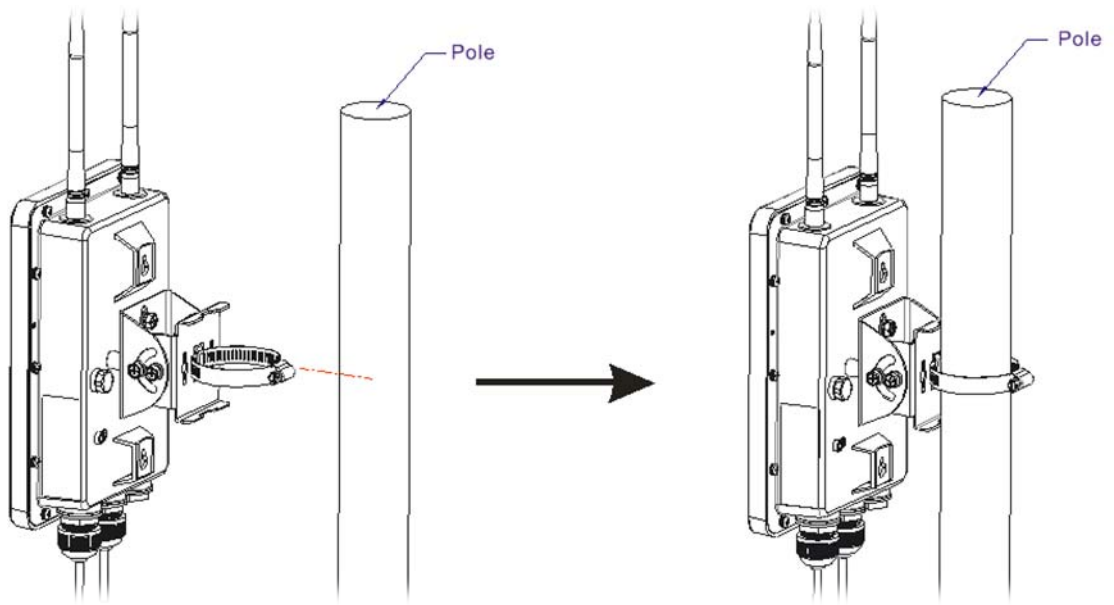

i Note:

The diameter for a pole shall be limited between 35mm to 60mm.

I-2-4 Pole Mount Installation – for VigorAP 918R

- 1. Find a suitable location for installing the access point.
- 2. Select a mounting point on a pole.
- 3. Insert the pipe clamp on the access point. Press the pipe clamp to open it for clamping the pole.

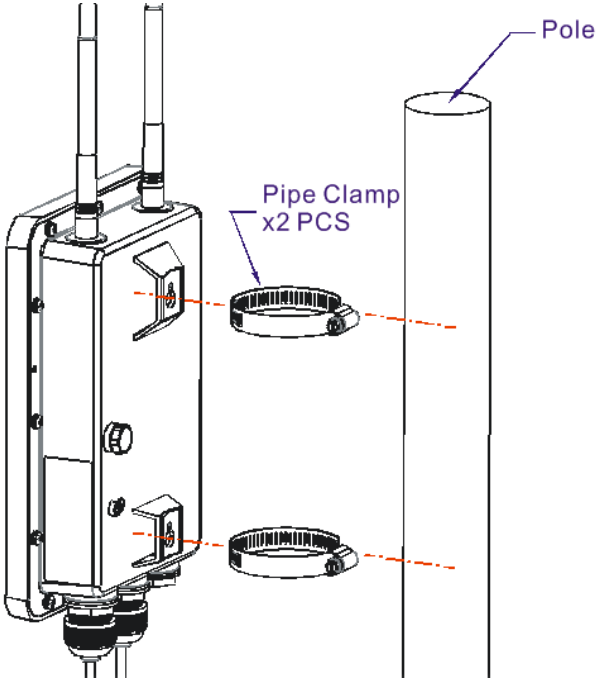

I-2-5 Wall Mount Installation – for VigorAP 918R

Refer to the following steps to mount the access point on the wall.

1. Find a suitable location for installing the access point.
2. Insert two pieces of anchor to the wall.
3. Lock the screws on the anchors.
4. Hang the access point on the anchors.

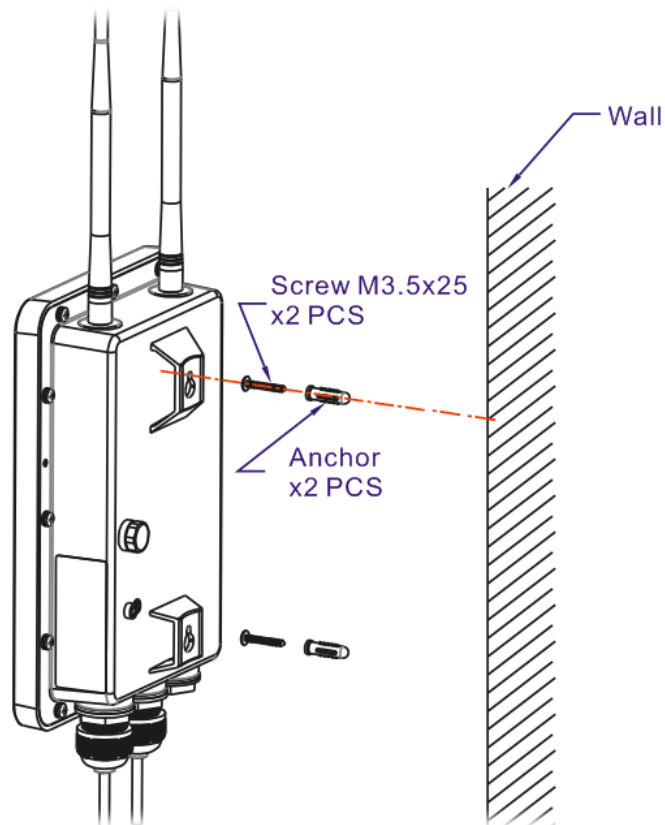

I-2-6 Grounding Access Point

In outdoor installations and before powering the access point with AC power, VigorAP must be grounded prior to wire installation.

1. Take out the ground cable from the mount kit.

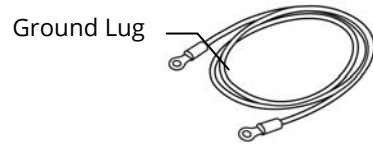

2. Insert a ground rod on the ground.
3. Strip the insulation for the ground lug.
4. Use the appropriate crimping tool to crimp the ground cable to the grounding lug.
5. Connect the ground rod and the VigorAP using the ground cable.

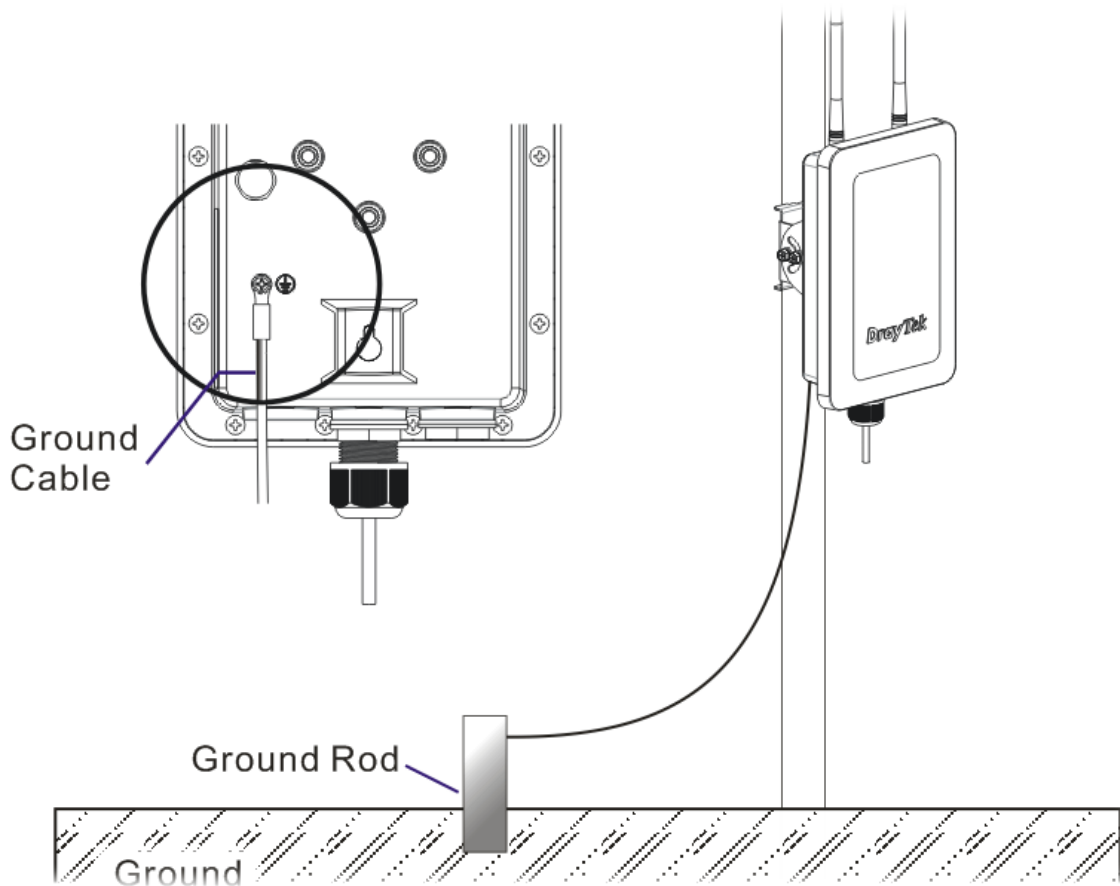

i Note:

Please consult an electrician if you are uncertain about the type of grounding that is required.

I-2-7 Powering Access Point

VigorAP 918R/RPD can be powered via the PoE input from an in-line power injector or a suitably powered switch port.



Before powering VigorAP, you should:

- Pay attention to local and national electrical codes.
- Not place the power injector / VigorSwitch in outdoor environment without any protection. Moisture might get into the power injector and cause a short circuit or possible fire.
- Not work on the system during periods of lightning activity to avoid the risk of electric shock, and do not connect or disconnect the Ethernet cables under bad weather.

Below shows two examples of connecting power for VigorAP 918R and VigorAP 918RPD.

Example 1: AP918R

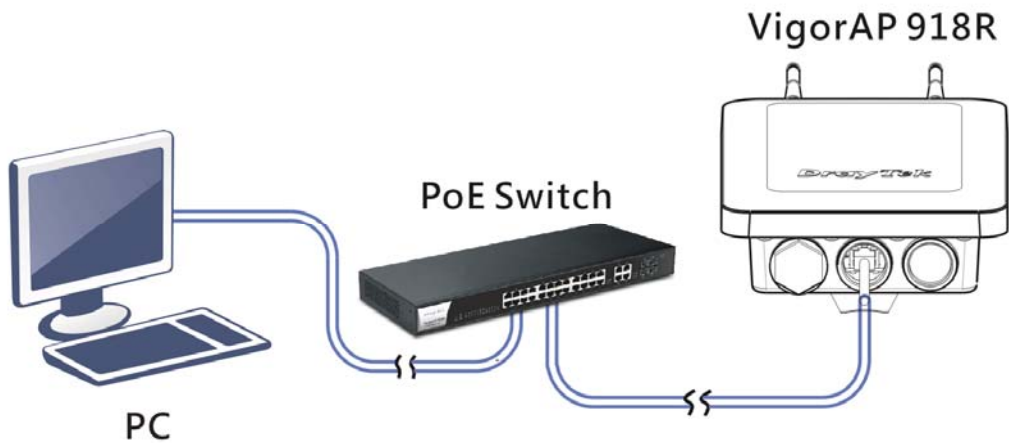

Example 2: AP918RPD

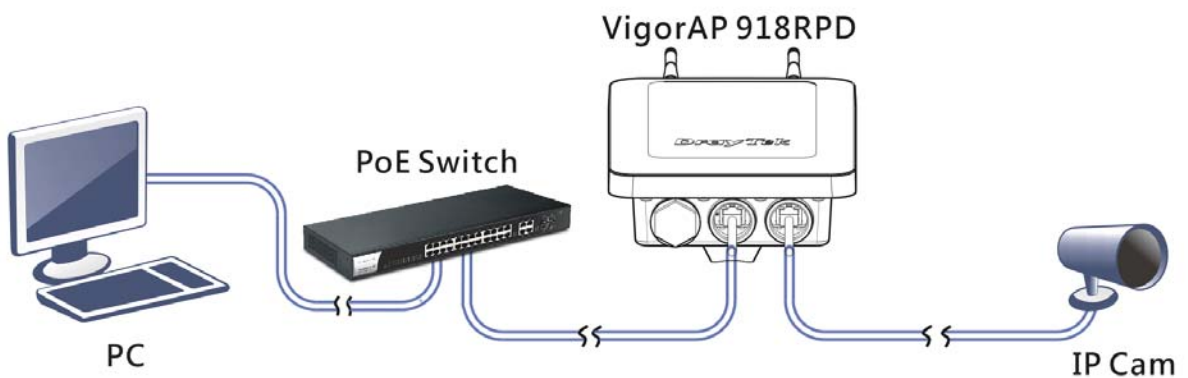

I-3 Network IP Configuration

After the network connection is built, the next step you should do is setup VigorAP 1000C with proper network parameters, so it can work properly in your network environment.

Before you can connect to the access point and start configuration procedures, your computer must be able to get an IP address in the same subnet as this AP. If it's not connected to the same DHCP Server with the AP or you're unsure, please follow the following instructions to configure your computer to use the static IP address in the same subnet as default IP address of this AP.

For the default IP address of this AP is set "192.168.1.2", we recommend you to use "192.168.1.X (except 2)" in the field of IP address on this section for your computer.

If the operating system of your computer is...

Windows 10 - please go to section I-3-1

I-3-1 Windows 10 IP Address Setup

Click the **Start** button (it should be located at lower-left corner of your computer), then click the **Settings** icon.

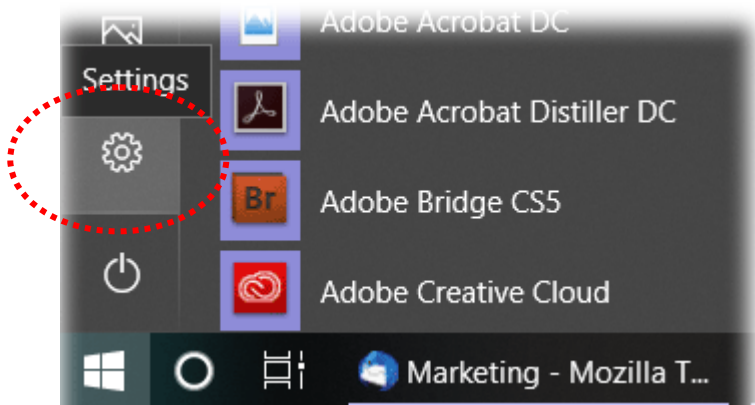

Double-click **Network & Internet**.

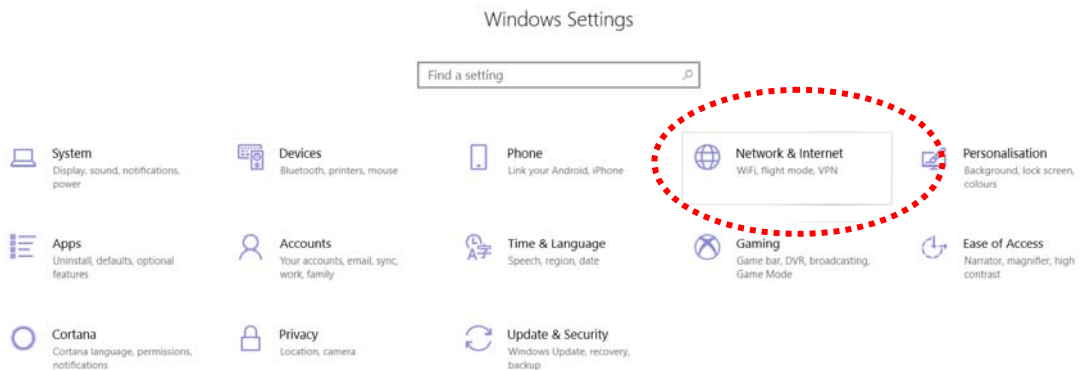

Next, click **Change adapter options**.

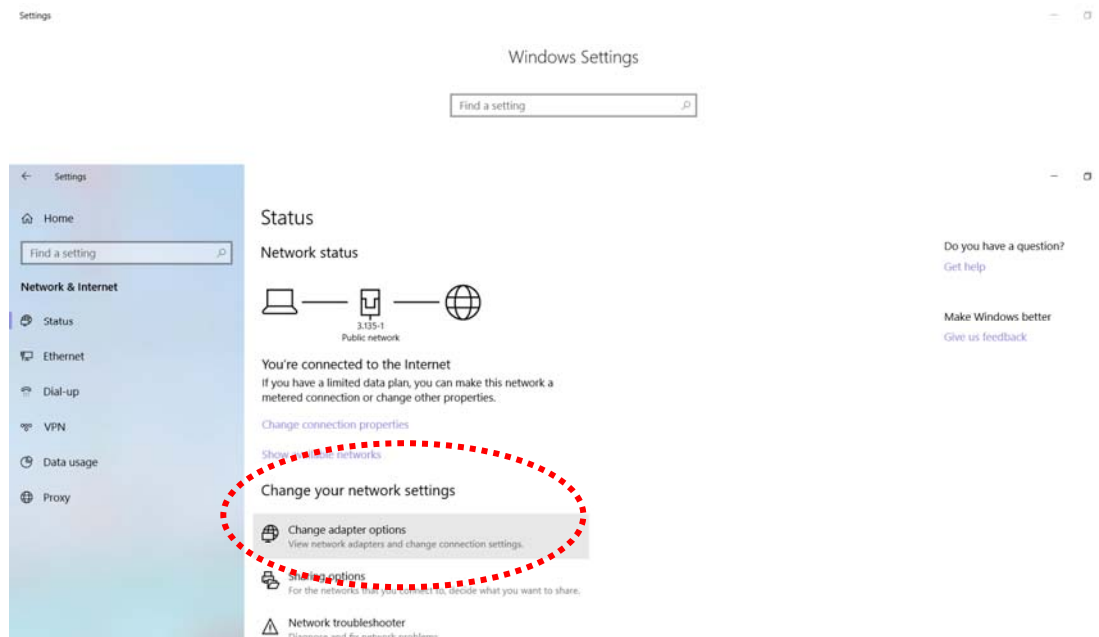

Click the local area connection.

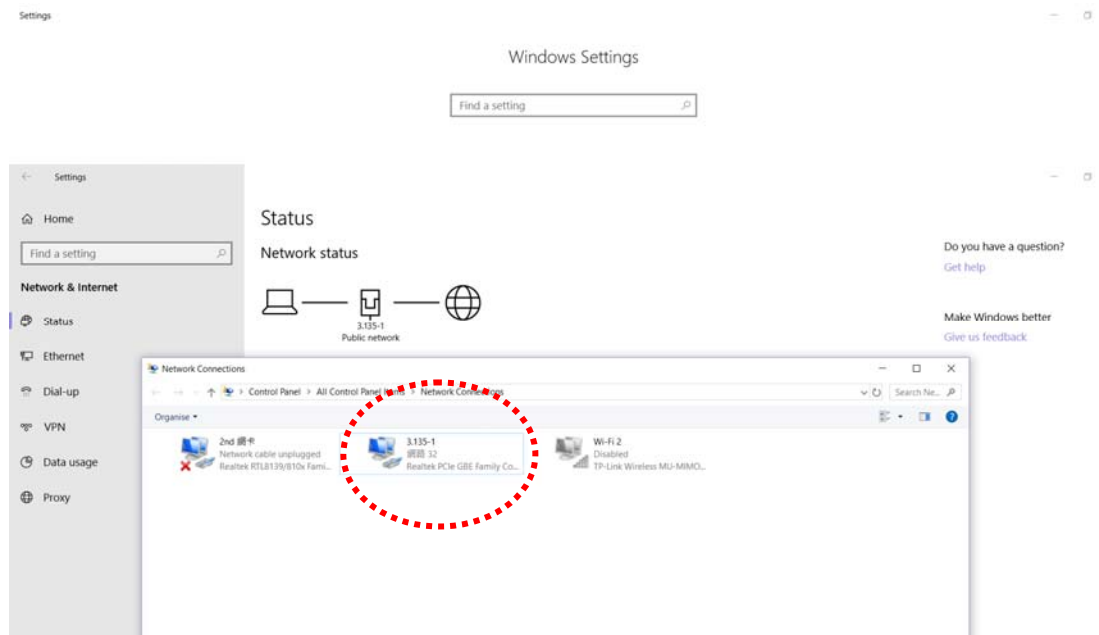

Then, select **Internet Protocol Version 4 (TCP/IPv4)** and click **Properties**.

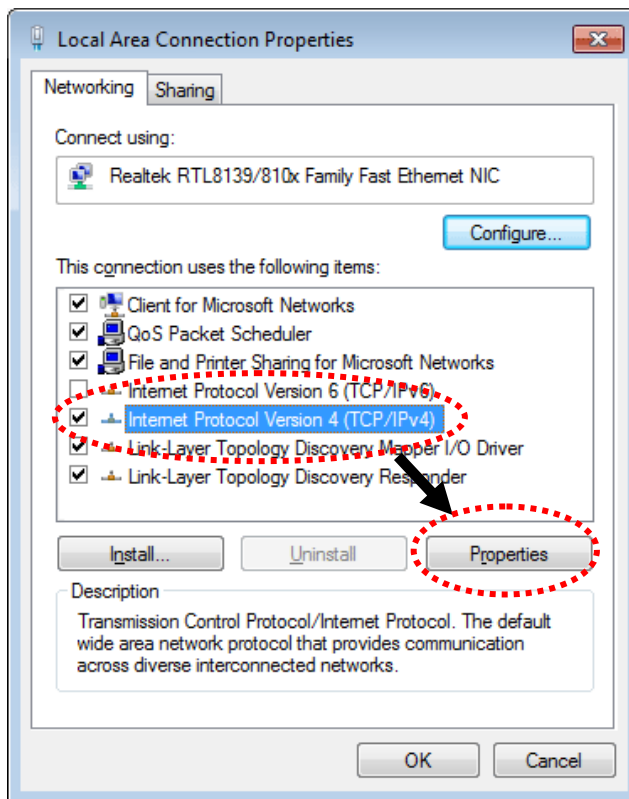

Under the General tab, click **Use the following IP address**. Then input the following settings in respective field and click **OK** when finish.

IP address: **192.168.1.9**

Subnet Mask: **255.255.255.0**

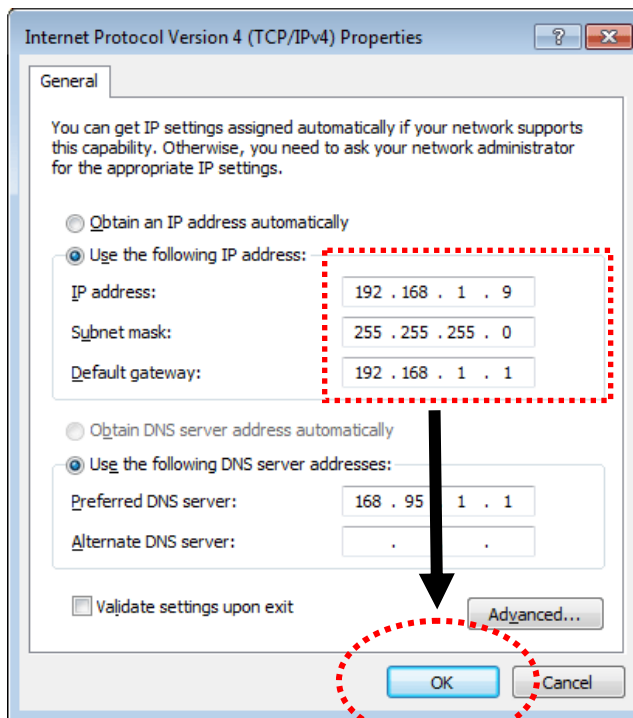

I-4 Accessing to Web User Interface

All functions and settings of this access point must be configured via web user interface. Please start your web browser (e.g., Firefox).

1. Make sure your PC connects to the VigorAP 918R correctly.
2. Open a web browser on your PC and type **http://192.168.1.2**. A pop-up window will open to ask for username and password. Please type "admin/admin" on Username/Password and click **OK**.

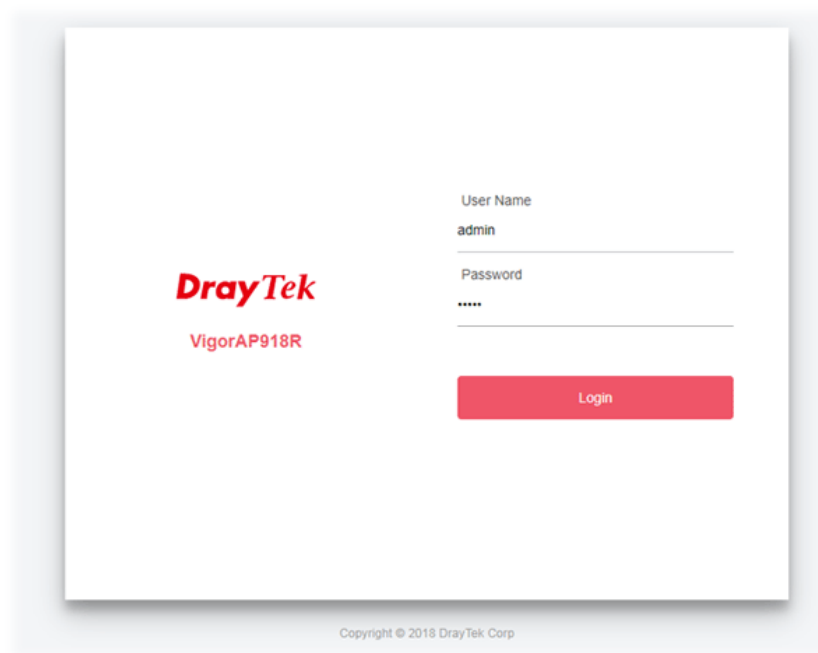

i Note:

You may either simply set up your computer to get IP dynamically from the router or set up the IP address of the computer to be in the same subnet as **the IP address of VigorAP 918R**.

- If there is no DHCP server on the network, then VigorAP 918R will have an IP address of 192.168.1.2.
 - If there is DHCP available on the network, then VigorAP 918R will receive its IP address via the DHCP server.
 - If you connect to VigorAP by wireless LAN, you could try to access the web user interface through <http://vigorap.com>.
-

- For the first time accessing VigorAP, the **Quick Start Wizard** for configuring wireless settings will appear as follows. Refer to [Section I-7 Quick Start Wizard for detailed information](#).

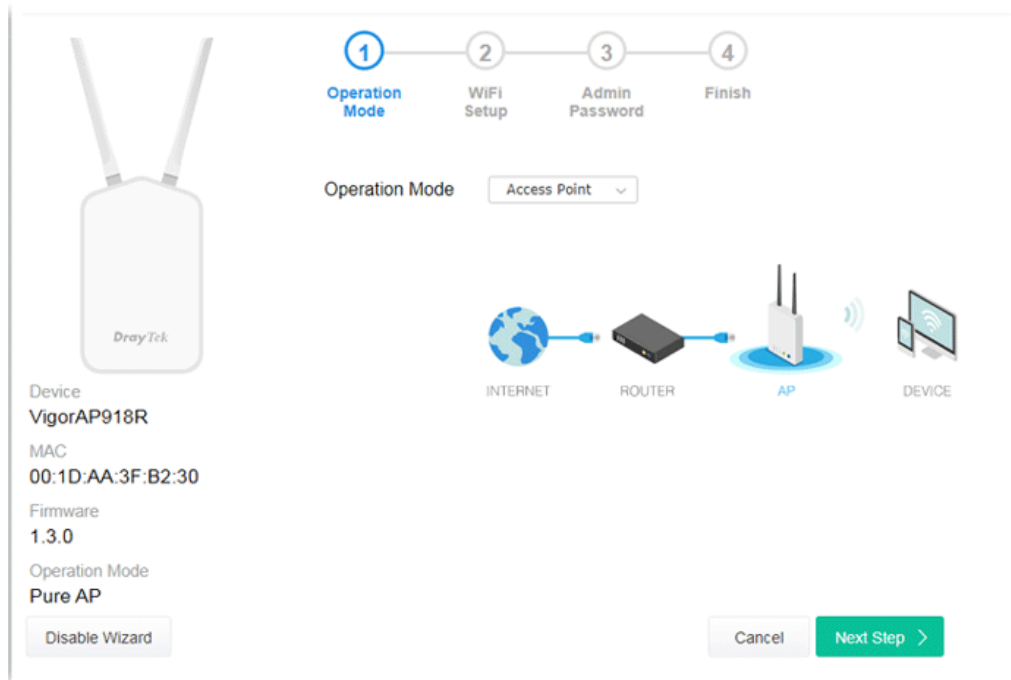

- If VigorAP has been configured previously, the Dashboard of VigorAP will appear as follows:

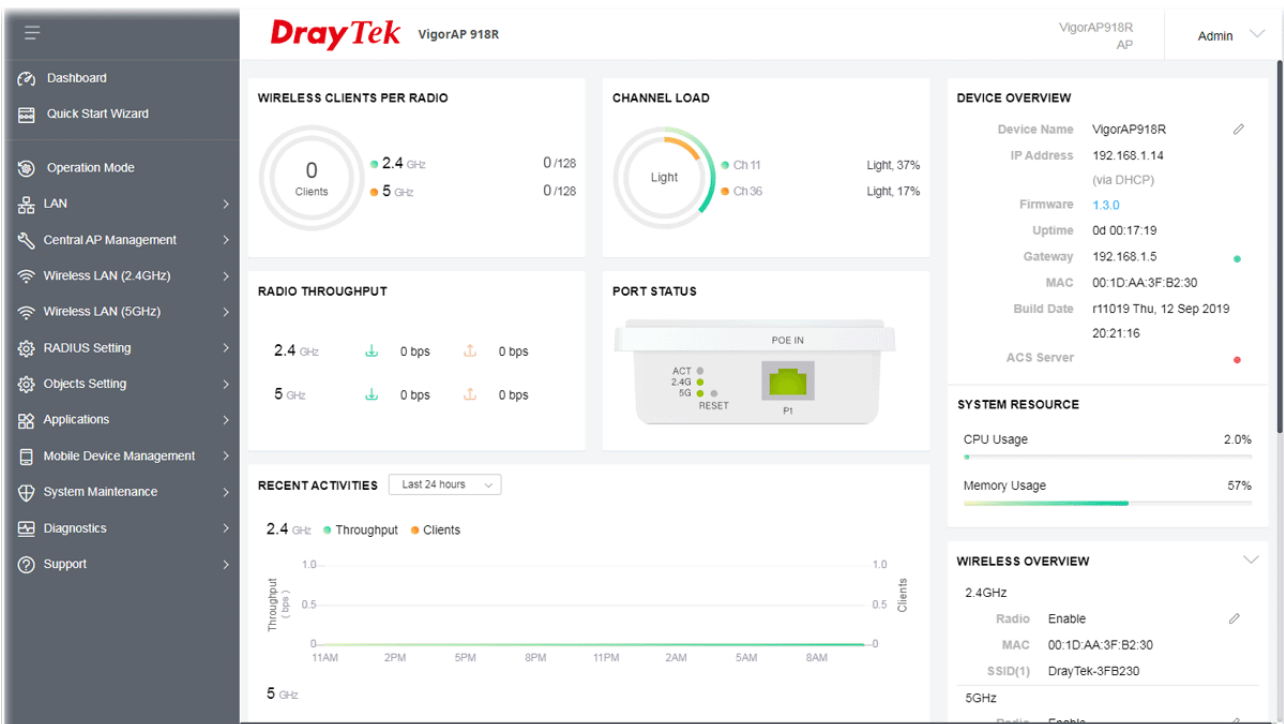

- The web page can be logged out by clicking **Log Out** on the top right of the web page. Or, logout the web user interface according to the chosen condition. The default setting is **Auto Logout**, which means the web configuration system will logout after 5 minutes without any operation. Change the setting of auto logout if you want.

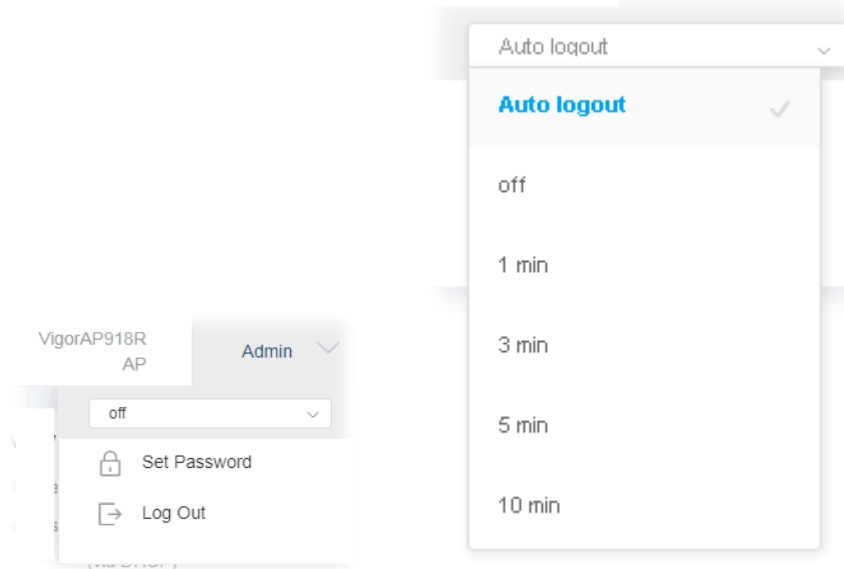

i Note:

If you fail to access the web configuration, please go to the section “Trouble Shooting” for detecting and solving your problem.

For using the device properly, it is necessary for you to change the password of web configuration for security and adjust primary basic settings.

I-5 Changing Password

1. Please change the password for the original security of the modem.
2. Go to **System Maintenance** page and choose **Administration Password**.

System Maintenance >> Administration Password

Administrator Settings

Account	<input type="text" value="admin"/>
Old Password	<input type="password" value="....."/>
New Password	<input type="password" value="....."/>
Confirm Password	<input type="password" value="....."/>
Password Strength:	<input type="button" value="Weak"/> <input checked="" type="button" value="Medium"/> <input type="button" value="Strong"/>
Strong password requirements:	
1. Have at least one upper-case letter and one lower-case letter.	
2. Including non-alphanumeric characters is a plus.	

Note : Authorization Account can contain only a-z A-Z 0-9 , ~ ` ! @ \$ % ^ * () _ + = { } [] | ; < > . ?
Authorization Password can contain only a-z A-Z 0-9 , ~ ` ! @ # \$ % ^ & * () _ + = { } [] \ ;
< > . ? /

3. Enter the new login password on the field of **Password**. Then click **OK** to continue.
4. Now, the password has been changed. Next time, use the new password to access the Web User Interface for this modem.

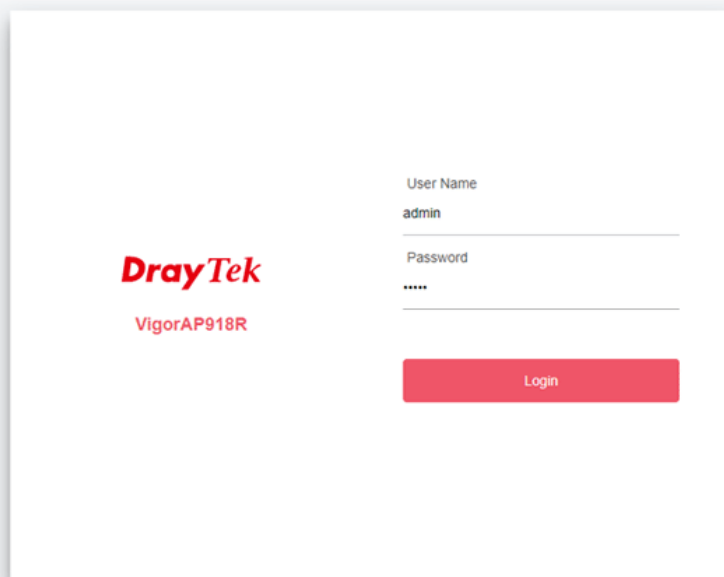

The image shows the login page for a DrayTek VigorAP918R modem. On the left, the DrayTek logo and model name are displayed. On the right, there are two input fields: 'User Name' with 'admin' entered and 'Password' with '.....' entered. Below the fields is a red 'Login' button. At the bottom of the page, there is a copyright notice: 'Copyright © 2018 DrayTek Corp'.

I-6 Dashboard

Dashboard shows system status including the number of client connected, throughput, gateway, physical connection status, radio (2.4GHz / 5GHz) status, backhaul network, recent activities, wireless network usage, and so on.

Click **Dashboard** from the main menu on the left side of the main page.

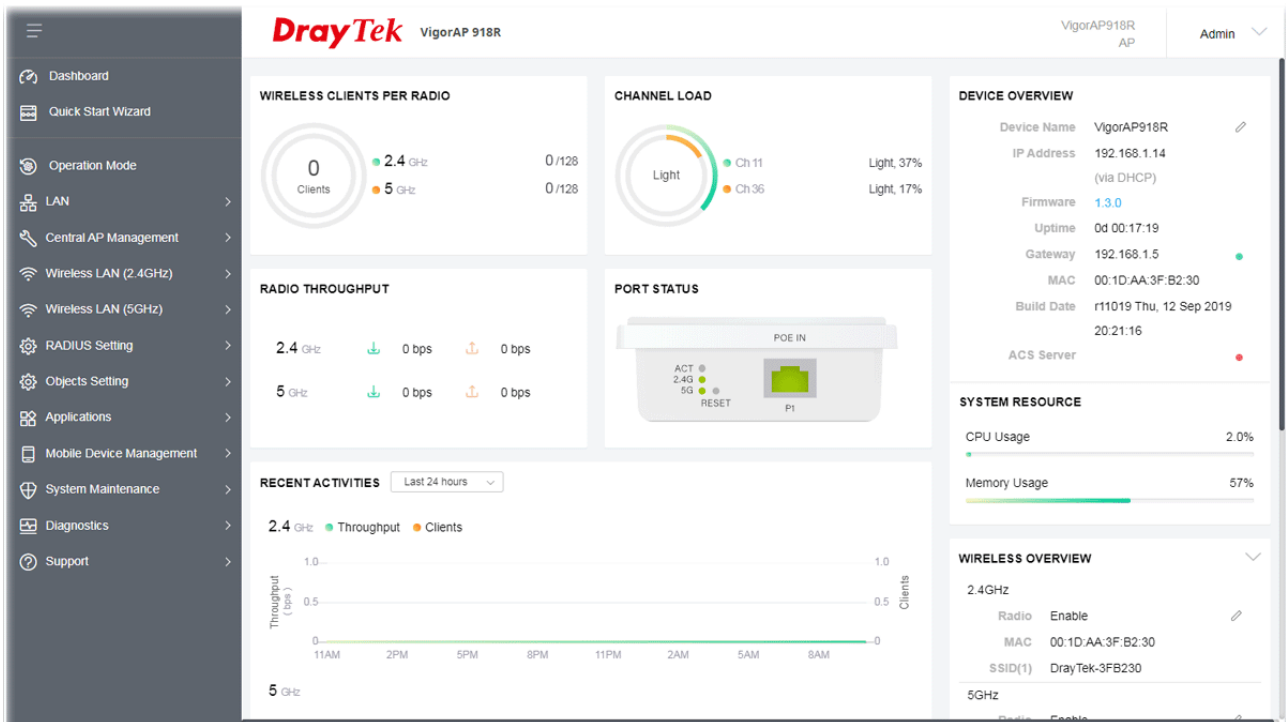

I-7 Quick Start Wizard

Quick Start Wizard will guide you to configure 2.4G wireless setting, 5G wireless setting and other corresponding settings for Vigor Access Point step by step.

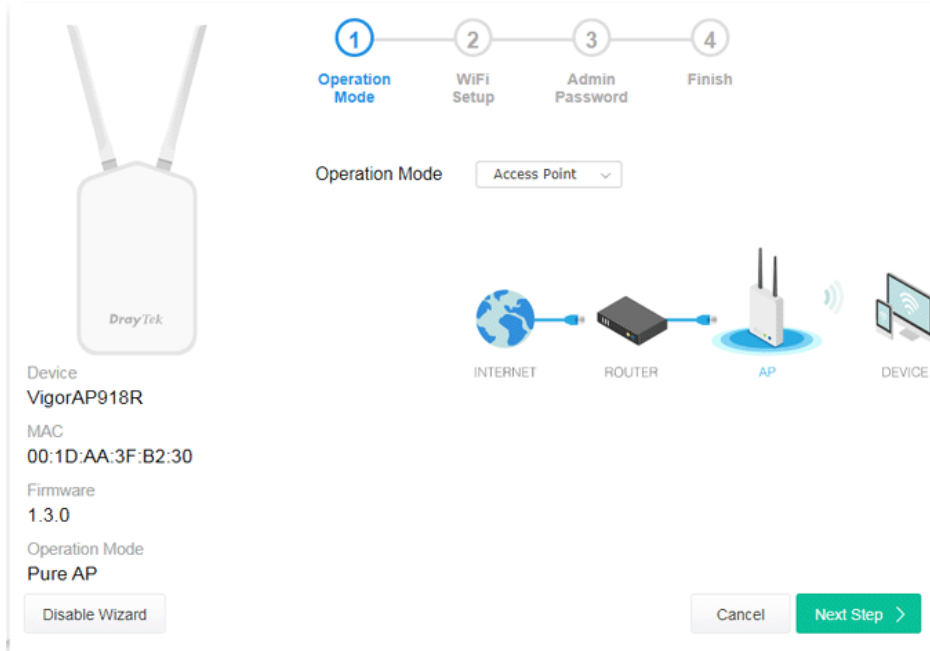

Available operation mode includes:

- Access Point
- Mesh Root
- Mesh Node
- Range Extender

In this page, the advanced settings pages will vary according to the operation mode specified.

I-7-1 Settings for Access Point

1. Choose **Access Point** as the operation mode and click **Next Step**.

Device
VigorAP918R
MAC
00:1D:AA:3F:B2:30
Firmware
1.3.0
Operation Mode
Pure AP

Operation Mode: Access Point

INTERNET ROUTER AP DEVICE

Cancel Next Step >

2. In the following page, configure the settings for wireless LAN (for both 2.4GHz and 5GHz) and click **Next Step**.

WiFi Name: DrayTek-3FB230
WiFi Password:

Enable 2nd WiFi
2nd WiFi Name: test_carrie
2nd WiFi Password:

Enable Bandwidth Limit
 Enable Station Control

Note: The WiFi settings will apply to all Wireless bands.

< Back Cancel Next Step >

Available settings are explained as follows:

Item	Description
WiFi Name	Set a name for VigorAP 918R to be identified.

WiFi Password	Type 8~63 ASCII characters, such as 012345678...(or 64 Hexadecimal digits leading by 0x, such as "0x321253abcde...").
Enable 2nd Wireless	<p>Check the box to enable the second wireless setting.</p> <p>Such feature is especially useful for free Wi-Fi service. For example, a coffee shop offers free Wi-Fi service for its guests for one hour every day.</p> <p>2nd WiFi Name - Set a name for VigorAP 918R which can be identified and connected by wireless guest.</p> <p>2nd WiFi Password - Set 8~63 ASCII characters which can be used for logging into VigorAP 918R by wireless guest.</p>
Enable Bandwidth Limit	<p>Check the box to define the maximum speed of the data uploading/downloading which will be used for the guest connecting to Vigor device with the same SSID.</p> <p>Upload Limit - Scroll the radio button to choose the value you want.</p> <p>Download Limit - Scroll the radio button to choose the value you want.</p>
Enable Station Control	<p>Check the box to set the duration for the guest connecting /reconnecting to Vigor device.</p> <p>Connection Time - Scroll the radio button to choose the value you want.</p> <p>Reconnection Time - Scroll the radio button to choose the value you want.</p>

3. Change the default password for such device with new value. Then click **Next Step**.

Available settings are explained as follows:

Item	Description
Admin Password	Enter a new password.
Confirm	Enter the new password again for confirmation.

Password

4. A summary of settings configuration will be shown on screen. Click **Finish**.



DrayTek

Device
VigorAP918R
MAC
00:1D:AA:3F:B2:30
Firmware
1.3.0
Operation Mode
Pure AP

< Back

1 — 2 — 3 — 4
Operation Mode WiFi Setup Admin Password Finish

Basic settings are completed. Press Finish button apply changes.

Operation Mode	Pure AP
WiFi Name	DrayTek-3FB230
2nd WiFi Name	test_carrie
Bandwidth Limit	Disabled
Station Control	Disabled

Cancel Finish

I-7-2 Settings for Mesh Root

1. Choose **Mesh Root** as the operation mode and click **Next Step**.

1 — 2 — 3 — 4
Operation Mode WiFi Setup Admin Password Finish

Operation Mode:

Group Name:

Device: VigorAP918R
 MAC: 00:1D:AA:3F:B2:30
 Firmware: 1.3.0
 Operation Mode: Pure AP

2. Configure the settings for wireless LAN (for both 2.4GHz and 5GHz) and click **Next Step**.

1 — 2 — 3 — 4
Operation Mode **WiFi Setup** Admin Password Finish

Your AP is under default config. Please setup first.

WiFi Name:

WiFi Password:

Enable 2nd WiFi

2nd WiFi Name:

2nd WiFi Password:

Enable Bandwidth Limit

Enable Station Control

Note: The WiFi settings will apply to all Wireless bands.

Available settings are explained as follows:

Item	Description
WiFi Name	Set a name for VigorAP 918R to be identified.
WiFi Password	Type 8~63 ASCII characters, such as 012345678..(or 64 Hexadecimal digits leading by 0x, such as "0x321253abcde...").

Confirm Password	Enter the new password again for confirmation.
-------------------------	--

4. A summary of settings configuration will be shown on screen. Click **Finish**.

Progress: 1 — 2 — 3 — 4
 Operation Mode WiFi Setup Admin Password Finish

Basic settings are completed. Press Finish button apply changes.

Operation Mode	Mesh Root
WiFi Name	DrayTek-3FB230
2nd WiFi Name	mk_carrie
Bandwidth Limit	Disabled
Station Control	Disabled

Device
 VigorAP918R
 MAC
 00:1D:AA:3F:B2:30
 Firmware
 1.3.0
 Operation Mode
 Pure AP

< Back Cancel Finish

5. After clicking **Finish**, the following web page appears. VigorAP will search for mesh node around the network.

Progress: 1 — 2 — 3
 Restart Wireless Mesh Node Setup Finish

Setup additional VigorAPs to Mesh network?

Please power up and wait for us to find it.

Device
 VigorAP918R
 MAC
 00:1D:AA:3F:B2:30
 Firmware
 1.3.0
 Operation Mode
 Mesh Root

< Back Sending settings to mesh node Search Cancel Apply

- Available VigorAP devices will be shown on the screen. Select the device (as a mesh node) for grouping under such mesh group and enter a device name for identification.

1 — 2 — 3
Restart Wireless Mesh Node Setup Finish

Setup additional VigorAPs to Mesh network?
Please power up and wait for us to find it.

Select	Model	MAC	Device Name
<input checked="" type="checkbox"/>	VigorAP903	00:50:7F:F1:92:16	<input type="text"/>
<input type="checkbox"/>			
<input type="checkbox"/>			
<input type="checkbox"/>			

Sending settings to mesh node Search

< Back Cancel Apply

- Click **Apply** and wait for a while.

1 — 2
Mesh Node Setup Finish

Setup additional VigorAPs to Mesh network?
Please power up and wait for us to find it.

Device
VigorAP918R
MAC
00:1D:AA:3F:B2:30
Firmware
1.3.0
Operation Mode
Mesh Root

Sending settings to mesh node

< Back Cancel Apply

8. Later, a summary page of mesh root with mesh node will be shown on the screen.

1 Mesh Node Setup 2 Finish

Setup 1 Mesh Root and 1 Mesh Node completed.

ROOT	VigorAP918R VigorAP918R	2 Node	1 Offline
	903_device VigorAP903	-55dbm	00:1D:AA:68:D6:68

Device
VigorAP918R
MAC
00:1D:AA:3F:B2:30
Firmware
1.3.0
Operation Mode
Mesh Root

< Back

Cancel Finish

Cancel Apply

I-7-3 Settings for Mesh Node

1. Choose **Mesh Node** as the operation mode and click **Next Step**.

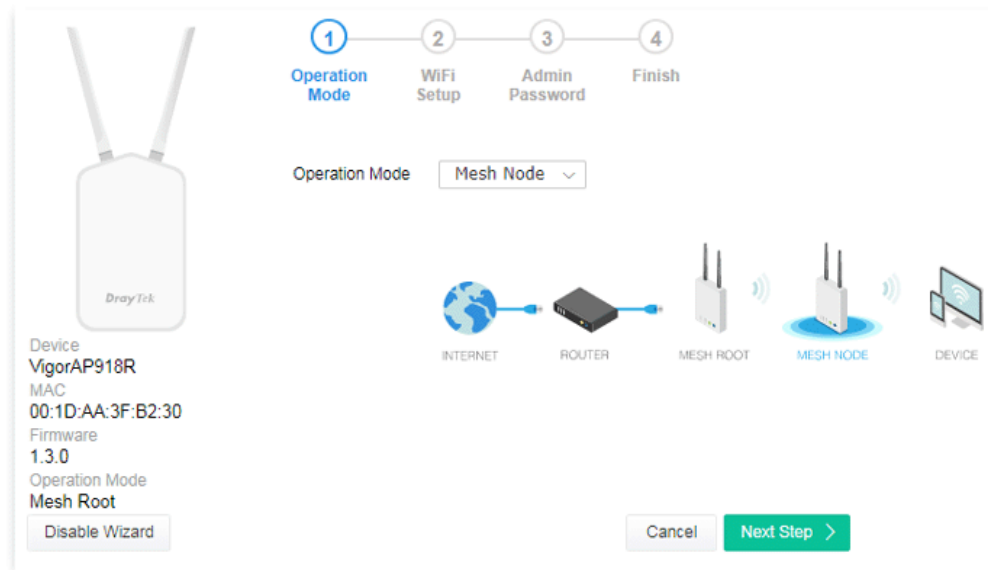

2. A summary of settings configuration will be shown on screen. Click **Finish**.

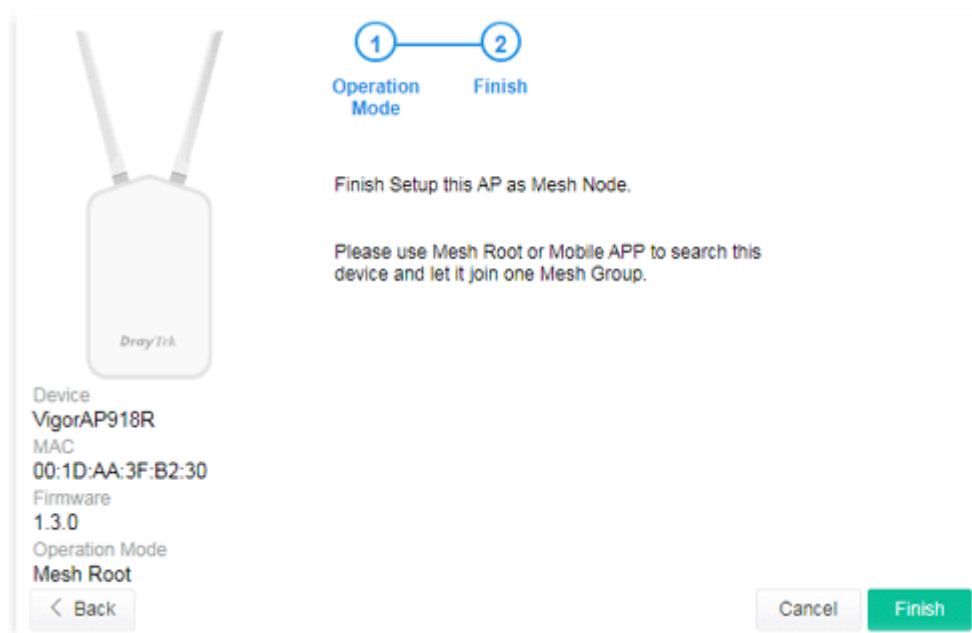

I-7-4 Settings for Range Extender

1. Choose **Range Extender** as the operation mode and click **Next Step**.

Device
VigorAP918R
MAC
00:1D:AA:3F:B2:30
Firmware
1.3.0
Operation Mode
Mesh Root
Disable Wizard

1 Operation Mode 2 WiFi Setup 3 Admin Password 4 Finish

Operation Mode Range Extender

AP RANGE EXTENDER DEVICE

Cancel Next Step >

2. Configure the settings for wireless LAN (for both 2.4GHz and 5GHz) and click **Next Step**.

1 Operation Mode 2 WiFi Setup 3 Admin Password 4 Range Extender 5 Finish

Your AP is under default config. Please setup first.

WiFi Name: DrayTek-3FB230
WiFi Password:

Enable 2nd WiFi
2nd WiFi Name: mk_carrie
2nd WiFi Password:

Enable Bandwidth Limit
 Enable Station Control

Note: The WiFi settings will apply to all Wireless bands.

< Back Cancel Next Step >

Available settings are explained as follows:

Item	Description
WiFi Name	Set a name for VigorAP 918R to be identified.
WiFi Password	Type 8~63 ASCII characters, such as 012345678..(or 64 Hexadecimal

	digits leading by 0x, such as "0x321253abcde...").
Enable 2nd WiFi	<p>Check the box to enable the second wireless setting.</p> <p>Such feature is especially useful for free Wi-Fi service. For example, a coffee shop offers free Wi-Fi service for its guests for one hour every day.</p> <p>2nd WiFi Name - Set a name for VigorAP 918R which can be identified and connected by wireless guest.</p> <p>2nd WiFi Password - Set 8~63 ASCII characters or 8~63 ASCII characters which can be used for logging into VigorAP 918R by wireless guest.</p>
Enable Bandwidth Limit	<p>Check the box to define the maximum speed of the data uploading/downloading which will be used for the guest connecting to Vigor device with the same SSID.</p> <p>Upload Limit – Scroll the radio button to choose the value you want.</p> <p>Download Limit –Scroll the radio button to choose the value you want.</p>
Enable Station Control	<p>Check the box to set the duration for the guest connecting /reconnecting to Vigor device.</p> <p>Connection Time –Scroll the radio button to choose the value you want.</p> <p>Reconnection Time –Scroll the radio button to choose the value you want.</p>

3. Change the default password for such device with new value. Then click **Next Step**.

The screenshot shows the configuration interface for a DrayTek VigorAP918R. On the left is an image of the device. Below it, the following information is displayed:

- Device: VigorAP918R
- MAC: 00:1D:AA:3F:B2:30
- Firmware: 1.3.0
- Operation Mode: Mesh Root

At the bottom left of the device image is a '< Back' button. At the top right, a progress bar shows five steps: 1. Operation Mode, 2. WiFi Setup, 3. Admin Password (current step), 4. Range Extender, and 5. Finish. Below the progress bar, a message reads: 'Your AP is under default config. Please setup first.' There are two input fields for 'Admin Password' and 'Confirm Password', both containing five dots. At the bottom right, there are 'Cancel' and 'Next Step >' buttons.

Available settings are explained as follows:

Item	Description
Admin Password	Enter a new password.

Confirm Password	Enter the new password again for confirmation.
-------------------------	--

4. In the following page, click **Search** to find out neighboring access point. When all the available access points appear on the page, click the one you want to connect. Corresponding settings (e.g., SSID, security key) of the selected device will be shown below. Then click **Next Step**.

Device: VigorAP918R
MAC: 00:1D:AA:3F:B2:30
Firmware: 1.3.0
Operation Mode: Mesh Root

SSID	BSSID	RSSI	Channel	Encryption	Authentication
DrayTek-223344	00:1D:AA:04:F0:6C	56% (-75dbm)	11	TKIP/AES	Mixed(WPA+WPA2)/PSK
ap912c-BandStee...	00:1D:AA:3F:75:82	95% (-58dbm)	11	AES	WPA2/PSK
DrayTek	00:1D:AA:80:06:B8	73% (-70dbm)	11	TKIP/AES	Mixed(WPA+WPA2)/PSK
AP920R PQC Tang	00:1D:AA:63:2C:00	90% (-65dbm)	11	TKIP/AES	Mixed(WPA+WPA2)/PSK
DrayTek575D38	02:50:7F:C1:92:16	90% (-65dbm)	11	TKIP/AES	Mixed(WPA+WPA2)/PSK

SSID: Channel: 2462MHz (Channel 11) Security Mode: WPA2/PSK Encryption Type: AES
Security Key:

Available settings are explained as follows:

Item	Description
SSID/Security Key	Once the access point specified above, the name / security key of the AP will be shown automatically in these fields.
Channel	Means the channel frequency of the wireless LAN. You may switch channel if the selected channel is under serious interference.
Security Mode	There are several modes provided for you to choose. Each mode will bring up different parameters (e.g., WEP keys, Pass Phrase) for you to configure.
Encryption Type	Available options will vary according to the selected Security Mode . When Open is selected: <ul style="list-style-type: none"> Choose None to disable the WEP Encryption. Data sent to the AP will not be encrypted. WEP Keys -To enable WEP encryption for data transmission, please choose WEP. Four keys can be entered here, but only one key can be selected at a time. The format of WEP Key is restricted to 5 ASCII characters or 10 hexadecimal values in 64-bit encryption level, or restricted to 13 ASCII characters or 26 hexadecimal values in 128-bit encryption level. The allowed content is the ASCII characters from 33(!) to 126(~) except '#' and '·'. When Shared is selected: <ul style="list-style-type: none"> WEP Keys - To enable WEP encryption for data transmission, please choose WEP. Four keys can be entered here, but only one key can be selected at a time. The format of WEP Key is restricted to 5 ASCII characters or 10 hexadecimal values in 64-bit

encryption level, or restricted to 13 ASCII characters or 26 hexadecimal values in 128-bit encryption level. The allowed content is the ASCII characters from 33(!) to 126(~) except '#' and '.'.

When WPA/PSK or WPA2/PSK is selected:

- Select **TKIP** or **AES** as the algorithm for WPA.
- **Security Key** - Select WEP, TKIP or AES as the encryption algorithm.

Type **8~63** ASCII characters, such as 012345678..(or 64 Hexadecimal digits leading by 0x, such as "0x321253abcde...").

5. A summary of settings configuration will be shown on screen. Click **Finish**.

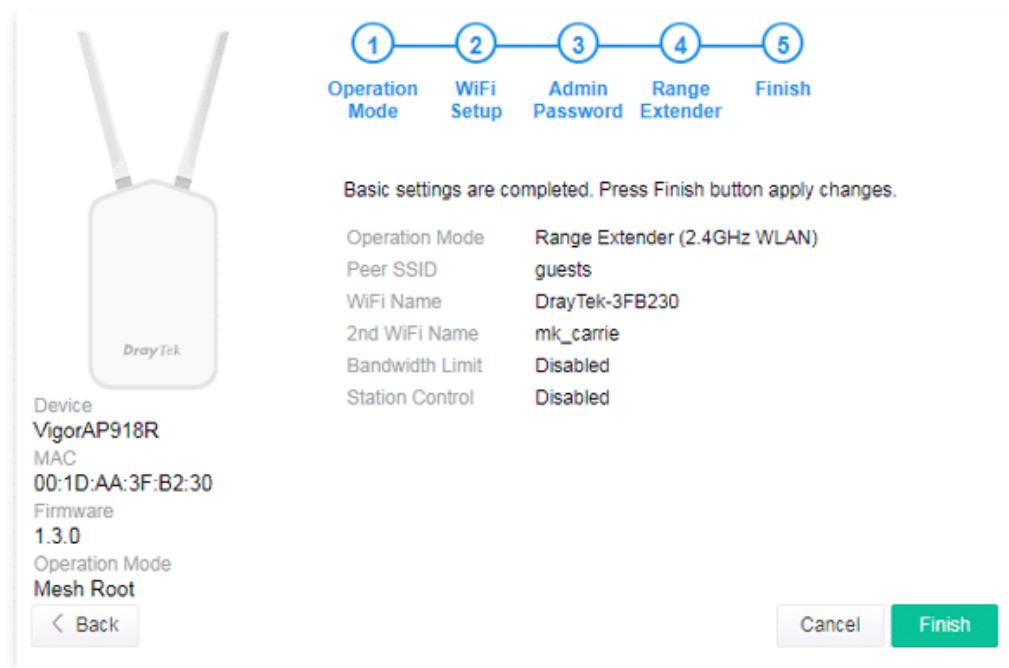

This page is left blank.

Chapter II Connectivity

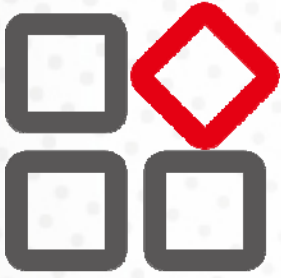

II-1 Operation Mode

This page provides several available modes for you to choose for different conditions. Click any one of them and click **OK**. The system will configure the required settings automatically.

Operation Mode Configuration

AP :

VigorAP acts as a bridge between wireless devices and wired Ethernet network, and exchanges data between them.

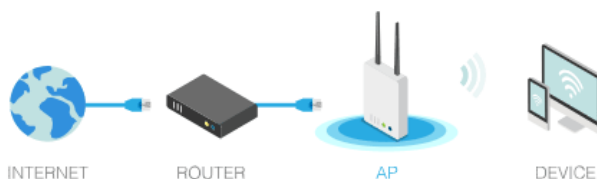

Mesh :

Mesh Root:

AP connects to gateway with Ethernet cable. It would be other AP's uplink connection.

Mesh Node:

Use wireless to connect to other Mesh Root when Ethernet cable doesn't exist. A mesh network creates a set of links automatically and calculate the most optimal wireless path through the wireless network back to a wired Mesh Root.

Range Extender :

VigorAP can act as a wireless repeater; it can be Station and AP at the same time.

OK

Available settings are explained as follows:

Item	Description
AP	This mode allows wireless clients to connect to access point and exchange data with the devices connected to the wired network.
Mesh	Mesh Root – VigorAP must connect to a gateway with an Ethernet cable. Mesh Node – VigorAP can connect to other mesh root via wireless connection. A mesh network creates one set of links automatically and calculates the most optimal wireless path through the wireless network back to a wired mesh root.
Range Extender	VigorAP can act as a wireless repeater which will help you to extend the networking wirelessly. The access point can act as Station and AP at the same time. It can use Station function to connect to a Root AP and use AP function to service all wireless clients within its coverage.

i Note:

The Wireless LAN settings will be changed according to the Operation Mode selected here. For the detailed information, please refer to the section of Wireless LAN.

II-2 General Concepts for Wireless LAN (2.4GHz/5GHz)

VigorAP 918R is a highly integrated wireless local area network (WLAN) for 5 GHz 802.11ac or 2.4/5 GHz 802.11n WLAN applications. It supports channel operations of 20/40 MHz at 2.4 GHz and 20/40/80 MHz at 5 GHz. VigorAP 918R can support data rates up to 867 MBps in 802.11ac 80 MHz channels.

Note:

* The actual data throughput will vary according to the network conditions and environmental factors, including volume of network traffic, network overhead and building materials.

VigorAP 918R plays a role as an Access Point (AP) connecting to lots of wireless clients or Stations (STA). All the STAs will share the same Internet connection via VigorAP 918R. The **General Setup** will set up the information of this wireless network, including its SSID as identification, located channel etc.

Security Overview

WEP (Wired Equivalent Privacy) is a legacy method to encrypt each frame transmitted via radio using either a 64-bit or 128-bit key. Usually access point will preset a set of four keys and it will communicate with each station using only one out of the four keys.

WPA (Wi-Fi Protected Access), the most dominating security mechanism in industry, is separated into two categories: WPA-personal or called WPA Pre-Share Key (WPA/PSK), and WPA-Enterprise or called WPA/802.1x.

In WPA-Personal, a pre-defined key is used for encryption during data transmission. WPA applies Temporal Key Integrity Protocol (TKIP) for data encryption while WPA2 applies AES. The WPA-Enterprise combines not only encryption but also authentication.

Since WEP has been proved vulnerable, you may consider using WPA for the most secure connection. You should select the appropriate security mechanism according to your needs. No matter which security suite you select, they all will enhance the over-the-air data protection and /or privacy on your wireless network. The VigorAP 918R is very flexible and can support multiple secure connections with both WEP and WPA at the same time.

WPS Introduction

WPS (Wi-Fi Protected Setup) provides easy procedure to make network connection between wireless station and wireless access point (VigorAP 918R) with the encryption of WPA and WPA2.



It is the simplest way to build connection between wireless network clients and VigorAP 918R. Users do not need to select any encryption mode and type any long encryption passphrase to setup a wireless client every time. He/she only needs to press a button on wireless client, and WPS will connect for client and VigorAP 918R automatically.

i Note:

Such function is available for the wireless station with WPS supported.

There are two methods to do network connection through WPS between AP and Stations: pressing the **Start PBC** button or using **PIN Code**.

On the side of VigorAP 918R series which served as an AP, press **WPS** button once on the front panel of VigorAP 918R or click **Start PBC** on web configuration interface. On the side of a station with network card installed, press **Start PBC** button of network card.

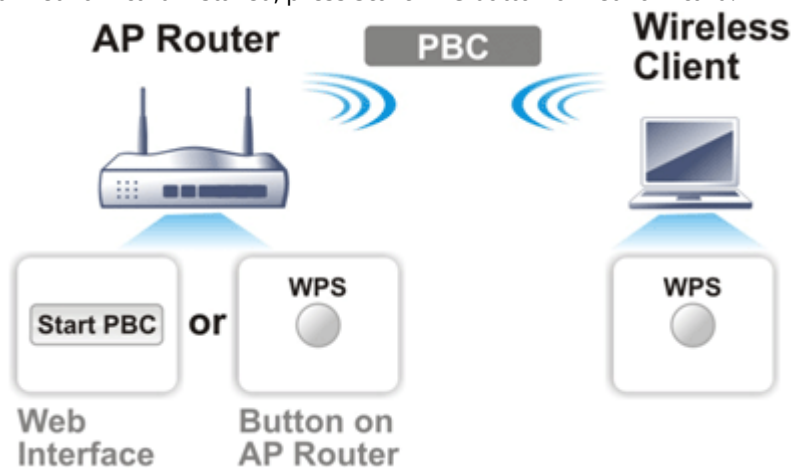

If you want to use PIN code, you have to know the PIN code specified in wireless client. Then provide the PIN code of the wireless client you wish to connect to the VigorAP 918R.

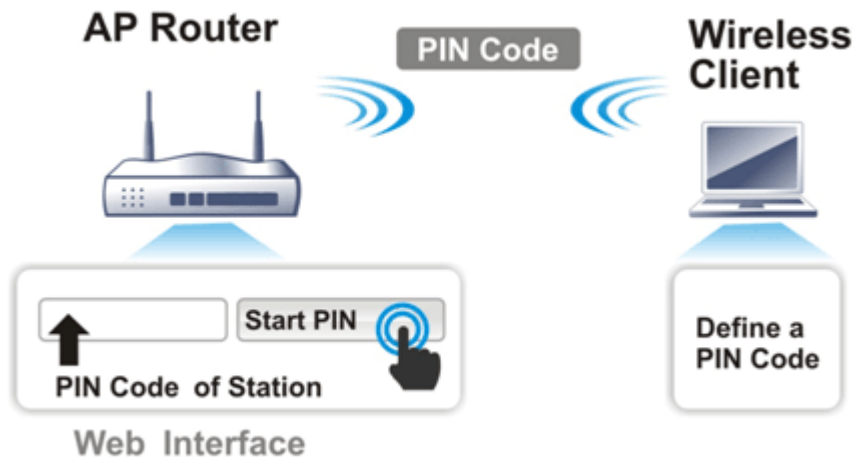

II-3 Wireless LAN (2.4GHz/5GHz) Settings for AP Mode

When you choose **AP** as the operation mode, the Wireless LAN menu items will include General Setup, Security, Access Control, WPS, Advanced Setting, AP Discovery, Bandwidth Management, Airtime Fairness, Station Control, Roaming, Band Steering and Station List.



i Note:

Available settings for **Wireless LAN (2.4GHz)** and **Wireless LAN (5GHz)** are almost the same, except for Band Steering.

The following figure shows how VigorAP runs as AP (Access Point)

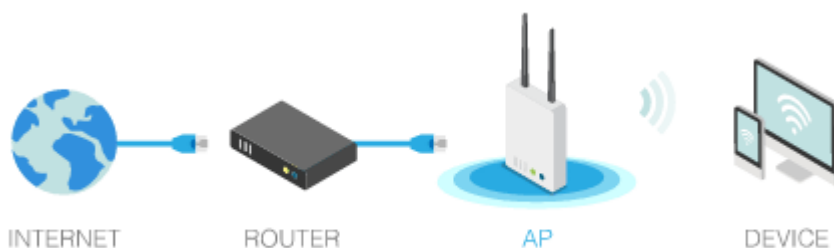

II-3-1 General Setup

By clicking the **General Setup**, a new web page will appear so that you could configure the SSID, the wireless channel and WDS (for 5GHz only). Please refer to the following figure for more information.

Wireless LAN (5GHz) >> General Setup

General Setting (IEEE 802.11)

Enable Wireless LAN

Enable Client Limit (3 ~ 128, default: 128)

Enable Client Limit per SSID (3 ~ 128, default: 128)

Mode :

Channel : (Active Channel: 36) [Filtered Out List](#)

Details : 20/40MHz Ext Ch: 40 , 80MHz Center Ch: 42

	Enable	Hide SSID	SSID	Isolate LAN	Isolate Member (0:Untagged)	VLAN ID
1	<input type="checkbox"/>	<input type="checkbox"/>	<input type="text" value="DrayTek-3FB230"/>	<input type="checkbox"/>	<input type="checkbox"/>	<input type="text" value="0"/>
2	<input checked="" type="checkbox"/>	<input type="checkbox"/>	<input type="text" value="mk_carrie"/>	<input type="checkbox"/>	<input type="checkbox"/>	<input type="text" value="0"/>
3	<input type="checkbox"/>	<input type="checkbox"/>	<input type="text"/>	<input type="checkbox"/>	<input type="checkbox"/>	<input type="text" value="0"/>
4	<input type="checkbox"/>	<input type="checkbox"/>	<input type="text"/>	<input type="checkbox"/>	<input type="checkbox"/>	<input type="text" value="0"/>

Hide SSID: Prevent SSID from being scanned.

Isolate LAN: Wireless clients (stations) with the same SSID cannot access wired PCs on LAN.

Isolate Member: Wireless clients (stations) with the same SSID cannot access for each other.

Isolate Exception: Isolate Exception can be created by adding the MAC from [Device Object](#).

WDS Settings (PHY Mode : HTMIX)

Security :

Disabled TKIP AES

Key :

Peer MAC Address :

1. : : : : :

2. : : : : :

3. : : : : :

4. : : : : :

Note: Enter the configuration of APs which AP918R want to connect.
Remote AP should always use LAN or SSID1 MAC address to connect AP918R WDS.

OK

Cancel

Available for
5GHz Access
Point Mode

Available settings are explained as follows:

Item	Description
Enable Wireless LAN	Check the box to enable wireless function.
Enable Client Limit	Check the box to set the maximum number of wireless stations which try to connect Internet through Vigor device. The number you can set is from 3 to 64.
Enable Client Limit per SSID	Define the maximum number of wireless stations per SSID which try to connect to Internet through Vigor device. The number you can set is from 3 to 64.
Mode	At present, VigorAP 918R can connect to 2.4GHz stations with 11n only, Mixed (11b+11g), and Mixed (11b+11g+11n) simultaneously, or to 5GHz stations with 11a only, 11n only(5G), Mixed (11a+11n) and Mixed (11a+11n+11ac) simultaneously. Simply choose Mixed (11b+11g+11n) / Mixed (11a+11n+11ac) mode.
Channel	Means the channel of frequency of the wireless LAN. You may switch channel if the selected channel is under serious interference. If you have no idea of choosing the frequency, please select AutoSelect to let system determine for you.
Extension Channel	With 802.11n, there is one option to double the bandwidth per channel. The available extension channel options will be varied according to the Channel selected above. Configure the extension channel you want.
Hide SSID	Check it to prevent from wireless sniffing and make it harder for unauthorized clients or STAs to join your wireless LAN. Depending on the wireless utility, the user may only see the information except SSID or just cannot see any thing about VigorAP 918R while site surveying. The system allows you to set four sets of SSID for different usage.
SSID	Set a name for VigorAP 918R to be identified. Default settings are DrayTek-LAN-A and DrayTek-LAN-B. When Enable 2 Subnet is enabled, you can specify subnet interface (LAN-A or LAN-B) for each SSID by using the drop down menu.
Isolate LAN	Check this box to isolate the wireless connection from LAN. It can make the wireless clients (stations) with remote-dial and LAN to LAN users not accessing for each other.
Isolate Member	Check this box to make the wireless clients (stations) with the same SSID not access for each other.
VLAN ID	Type the value for such SSID. Packets transferred from such SSID to LAN will be tagged with the number. If your network uses VLANs, you can assign the SSID to a VLAN on your network. Client devices that associate using the SSID are grouped into this VLAN. The VLAN ID range is from 3 to 4095. The VLAN ID is 0 by default, it means disabling the VLAN function for the SSID.
PHY Mode	Data will be transmitted via HTMIX mode. Each access point should be setup to the same Phy Mode for connecting with each other.
Security	Select WEP, TKIP or AES as the encryption algorithm. Type 8~63 ASCII characters, such as 012345678..(or 64 Hexadecimal

	digits leading by 0x, such as "0x321253abcde...").
Peer MAC Address	Type the peer MAC address for the access point that VigorAP 918R connects to.

After finishing this web page configuration, please click **OK** to save the settings.

II-3-2 Security

This page allows you to set security with different modes for SSID 1, 2, 3 and 4 respectively. After configuring the correct settings, please click **OK** to save and invoke it.

By clicking the **Security Settings**, a new web page will appear so that you could configure the settings.

Wireless LAN (5GHz) >> Security Settings

SSID 1
SSID 2
SSID 3
SSID 4

SSID DrayTek-3FB230

Mode

Set up [RADIUS Server](#) if 802.1x is enabled.

WPA

WPA Algorithms TKIP AES TKIP/AES

Pass Phrase

Key Renewal Interval seconds

EAPOL Key Retry Enable Disable

WEP

Key 1 :

Key 2 :

Key 3 :

Key 4 :

OK
Cancel

Available settings are explained as follows:

Item	Description
Mode	<p>There are several modes provided for you to choose.</p> <p>Disable - The encryption mechanism is turned off.</p> <p>WEP - Accepts only WEP clients and the encryption key should be entered in WEP Key.</p> <p>WPA/PSK or WPA2/PSK or Mixed (WPA+WPA2)/PSK - Accepts only WPA clients and the encryption key should be entered in PSK. The WPA encrypts each frame transmitted from the radio using the key, which either PSK (Pre-Shared Key) entered manually in this field below or automatically negotiated via 802.1x authentication.</p> <p>WEP/802.1x - The built-in RADIUS client feature enables VigorAP 918R to assist the remote dial-in user or a wireless station and the RADIUS server in performing mutual authentication. It enables centralized remote access authentication for network management.</p>

	<p>The WPA encrypts each frame transmitted from the radio using the key, which either PSK (Pre-Shared Key) entered manually in this field below or automatically negotiated via 802.1x authentication. Select WPA, WPA2 or Auto as WPA mode.</p> <p>WPA/802.1x - The WPA encrypts each frame transmitted from the radio using the key, which either PSK (Pre-Shared Key) entered manually in this field below or automatically negotiated via 802.1x authentication.</p> <p>WPA2/802.1x - The WPA encrypts each frame transmitted from the radio using the key, which either PSK (Pre-Shared Key) entered manually in this field below or automatically negotiated via 802.1x authentication.</p>
WPA Algorithms	Select TKIP, AES or TKIP/AES as the algorithm for WPA. Such feature is available for WPA2/802.1x, WPA/802.1x, WPA/PSK or WPA2/PSK or Mixed (WPA+WPA2)/PSK mode.
Pass Phrase	Type 8~63 ASCII characters, such as 012345678..(or 64 Hexadecimal digits leading by 0x, such as "0x321253abcde..."). Such feature is available for WPA/PSK or WPA2/PSK or Mixed (WPA+WPA2)/PSK mode.
Key Renewal Interval	WPA uses shared key for authentication to the network. However, normal network operations use a different encryption key that is randomly generated. This randomly generated key that is periodically replaced. Enter the renewal security time (seconds) in the column. Smaller interval leads to greater security but lower performance. Default is 3600 seconds. Set 0 to disable re-key. Such feature is available for WPA2/802.1, WPA/802.1x, WPA/PSK or WPA2/PSK or Mixed (WPA+WPA2)/PSK mode.
EAPOL Key Retry	EAPOL means Extensible Authentication Protocol over LAN. Click Enable to make sure that the key will be installed and used once in order to prevent key reinstallation attack.
Key 1 – Key 4	Four keys can be entered here, but only one key can be selected at a time. The format of WEP Key is restricted to 5 ASCII characters or 10 hexadecimal values in 64-bit encryption level, or restricted to 13 ASCII characters or 26 hexadecimal values in 128-bit encryption level. The allowed content is the ASCII characters from 33(!) to 126(~) except '#' and ','. Such feature is available for WEP mode.

Click the link of **RADIUS Server** to access into the following page for more settings.

The screenshot shows a web browser window titled "RADIUS Server Setup - Google Chrome". The address bar displays "192.168.1.13/wireless/radius.asp". The main content area is titled "Radius Server" and contains a form with the following elements:

- An unchecked checkbox labeled "Use internal RADIUS Server".
- An input field for "IP Address" containing the value "0".
- An input field for "Port" containing the value "1812".
- An input field for "Shared Secret" containing the value "DrayTek".
- An input field for "Session Timeout" containing the value "0" followed by the text "second(s)".
- A green "OK" button centered below the form.

Available settings are explained as follows:

Item	Description
Use internal RADIUS Server	<p>There is a RADIUS server built in VigorAP 918R which is used to authenticate the wireless client connecting to the access point. Check this box to use the internal RADIUS server for wireless security.</p> <p>Besides, if you want to use the external RADIUS server for authentication, do not check this box.</p> <p>Please refer to the section, IV-1-1 RADIUS Server to configure settings for internal server of VigorAP 918R.</p>
IP Address	Enter the IP address of external RADIUS server.
Port	The UDP port number that the external RADIUS server is using. The default value is 1812, based on RFC 2138.
Shared Secret	The external RADIUS server and client share a secret that is used to authenticate the messages sent between them. Both sides must be configured to use the same shared secret.
Session Timeout	Set the maximum time of service provided before re-authentication. Set to zero to perform another authentication immediately after the first authentication has successfully completed. (The unit is second.)

After finishing this web page configuration, please click **OK** to save the settings.

II-3-3 Access Control

For additional security of wireless access, the **Access Control** facility allows you to restrict the network access right by controlling the wireless LAN MAC address of client. Only the valid MAC address that has been configured can access the wireless LAN interface. By clicking the **Access Control**, a new web page will appear, as depicted below, so that you could edit the clients' MAC addresses to control their access rights (deny or allow).

Wireless LAN (5GHz) >> Access Control

SSID 1
SSID 2
SSID 3
SSID 4

SSID: DrayTek-3FB230

Policy: Disable

Index	MAC Address Filter	Comment
	MAC Address	

MAC Object

Device Group None or Device Object

None

Add Limit: 256 entries

OK
Cancel

Backup ACL Cfg :

Backup

Upload From File: Upload ...

Restore

Available settings are explained as follows:

Item	Description
Policy	Select to enable any one of the following policy or disable the policy. Choose Activate MAC address filter to type in the MAC addresses for other clients in the network manually. Choose Blocked MAC address filter , so that all of the devices with the MAC addresses listed on the MAC Address Filter table will be blocked and cannot access into VigorAP 918R.
MAC Address Filter	Display all MAC addresses that are edited before.
MAC	<p>Client's MAC Address - Manually enter the MAC address of wireless client.</p> <p>Add - Add a new MAC address into the list.</p> <p>Delete - Delete the selected MAC address in the list.</p>

	Edit - Edit the selected MAC address in the list.
Object	In addition to enter the MAC address of the device manually, you can Device Group - Select one of the existed device groups and click Add . All the devices belonging to the selected group will be shown on the MAC Address Filter table. Device Object - Select one of the existed device object and click Add . The MAC address of the device will be shown on the MAC Address Filter table.
Cancel	Give up the access control set up.
Backup	Click it to store the settings (MAC addresses on MAC Address Filter table) on this page as a file.
Restore	Click it to restore the settings (MAC addresses on MAC Address Filter table) from an existed file.

After finishing this web page configuration, please click **OK** to save the settings.

II-3-4 WPS

Open **Wireless LAN>>WPS** to configure the corresponding settings.

Wireless LAN (5GHz) >> WPS (Wi-Fi Protected Setup)

Enable WPS 

Wi-Fi Protected Setup Information

WPS Configured	Yes
WPS SSID	DrayTek-3FB230
WPS Auth Mode	WPA2/PSK
WPS Encrypt Type	AES

Device Configure

Configure via Push Button	<input type="button" value="Start PBC"/>
Configure via Client PinCode	<input type="button" value="Start PIN"/>

Status: Idle

Note: WPS can help your wireless client automatically connect to the Access point.

: WPS is Disabled.

: WPS is Enabled.

: Waiting for WPS requests from wireless clients.

Available settings are explained as follows:

Item	Description
Enable WPS	Check this box to enable WPS setting.
WPS Configured	Display related system information for WPS. If the wireless security (encryption) function of VigorAP 918R is properly configured, you can see 'Yes' message here.
WPS SSID	Display current selected SSID.
WPS Auth Mode	Display current authentication mode of the VigorAP 918R. Only WPA2/PSK and WPA/PSK support WPS.

WPS Encrypt Type	Display encryption mode (None, WEP, TKIP, AES, etc.) of VigorAP 918R.
Configure via Push Button	Click Start PBC to invoke Push-Button style WPS setup procedure. VigorAP 918R will wait for WPS requests from wireless clients about two minutes. Both ACT and 2.4G WLAN LEDs on VigorAP 918R will blink quickly when WPS is in progress. It will return to normal condition after two minutes. (You need to setup WPS within two minutes)
Configure via Client PinCode	Type the PIN code specified in wireless client you wish to connect, and click Start PIN button. Both ACT and 2.4G WLAN LEDs on VigorAP 918R will blink quickly when WPS is in progress. It will return to normal condition after two minutes. (You need to setup WPS within two minutes).

II-3-5 Advanced Setting

This page is to determine which algorithm will be selected for wireless transmission rate.

Wireless LAN (5GHz) >> Advanced Setting

Channel Bandwidth 20 MHz Auto 20/40 MHz Auto 20/40/80 MHz

Tx Power 100% 80% 60% 30% 20%
 10%

Fragment Length (256 - 2346) bytes

RTS Threshold (1 - 2347) bytes

Country Code (Reference)

36 40 44 48 149 153 157 161

Auto Channel Filtered Out List 165

IGMP Snooping Enable Disable

Isolate 2.4GHz and 5GHz bands Enable Disable

Isolate members with IP Enable Disable

WMM Capable Enable Disable

APSD Capable Enable Disable

Note: Fragment Length takes effect when mode is "11a Only".

Available settings are explained as follows:

Item	Description
Channel Width	<p>20 MHz- The device will use 20MHz for data transmission and receiving between the AP and the stations.</p> <p>Auto 20/40 MHz-The AP will scan for nearby wireless AP, and then use 20MHz if the number of AP is more than 10, or use 40MHz if it's not.</p> <p>40 MHz- The device will use 40MHz for data transmission and</p>

	<p>receiving between the AP and the stations. It is for wireless LAN 2.4GHz only.</p> <p>Auto 20/40 /80 MHz - The device will use 20/40/80 MHz channel bandwidth for data transmission and receiving between the AP and the stations.</p>
Antenna (for 2.4GHz only)	VigorAP can be attached with two antennas to have good data transmission via wireless connection. However, if you have only one antenna attached, please choose 1T1R.
Tx Power	The default setting is the maximum (100%). Lowering down the value may degrade range and throughput of wireless.
Fragment Length	Set the Fragment threshold of wireless radio. Do not modify default value if you don't know what it is, default value is 2346.
RTS Threshold	<p>Minimize the collision (unit is bytes) between hidden stations to improve wireless performance.</p> <p>Set the RTS threshold of wireless radio. Do not modify default value if you don't know what it is, default value is 2347.</p>
Country Code	VigorAP broadcasts country codes by following the 802.11d standard. However, some wireless stations will detect / scan the country code to prevent conflict occurred. If conflict is detected, wireless station will be warned and is unable to make network connection. Therefore, changing the country code to ensure successful network connection will be necessary for some clients.
Auto Channel Filtered Out List	The selected wireless channels will be discarded if AutoSelect is selected as Channel selection mode in Wireless LAN>>General Setup .
IGMP Snooping	Click Enable to enable IGMP Snooping. Multicast traffic will be forwarded to ports that have members of that group. Disabling IGMP snooping will make multicast traffic treated in the same manner as broadcast traffic.
Isolate 2.4GHz and 5GHz bands	<p>The default setting is "Enable". It means that the wireless client using 2.4GHz band is unable to connect to the wireless client with 5GHz band, and vice versa.</p> <p>For WLAN 2.4GHz and 5GHz set with the same SSID name:</p> <ul style="list-style-type: none"> ● No matter such function is enabled or disabled, clients using WLAN 2.4GHz and 5GHz can communicate for each other if Isolate Member (in Wireless LAN>>General Setup) is NOT enabled for such SSID. ● Yet, if the function of Isolate Member (in Wireless LAN>>General Setup) is enabled for such SSID, clients using WLAN 2.4GHz and 5GHz will be unable to communicate with each other.
Isolate members with IP	<p>The default setting is "Disable".</p> <p>If it is enabled, VigorAP will isolate different wireless clients according to their IP address(es).</p>
WMM Capable	To apply WMM parameters for wireless data transmission, please click the Enable radio button.
APSD Capable	APSD (automatic power-save delivery) is an enhancement over the power-save mechanisms supported by Wi-Fi networks. It allows devices to take more time in sleeping state and consume less power

	to improve the performance by minimizing transmission latency. The default setting is Disable .
MAC Clone (for 2.4GHz only)	Click Enable and manually enter the MAC address of the device with SSID 1. The MAC address of other SSIDs will change based on this MAC address.

After finishing this web page configuration, please click **OK** to save the settings.

II-3-6 AP Discovery

VigorAP 918R can scan all regulatory channels and find working APs in the neighborhood. Based on the scanning result, users will know which channel is clean for usage. Also, it can be used to facilitate finding an AP for a WDS link. Notice that during the scanning process (about 5 seconds), no client is allowed to connect to VigorAP.

This page is used to scan the existence of the APs on the wireless LAN. Please click **Scan** to discover all the connected APs.

Wireless LAN (5GHz) >> Access Point Discovery

Access Point List

Select	Index	SSID	BSSID	RSSI	Channel	Encryption	Authentication
<input type="radio"/>	1	DrayTek5G	00:1D:AA:80:06:BA	36%(-81dbm)	36	AES	WPA2/PSK
<input type="radio"/>	2	DrayTek575...	00:1D:AA:57:5D:39	8%(-89dbm)	36	TKIP/AES	Mixed(WPA+WPA2)/PSK
<input type="radio"/>	3		12:1D:AA:63:2C:11	62%(-73dbm)	36	AES	WPA2/PSK
<input type="radio"/>	4	DrayTek575...	00:50:7F:F1:92:16	22%(-85dbm)	36	TKIP/AES	Mixed(WPA+WPA2)/PSK
<input type="radio"/>	5	DrayTek_5G	00:1D:AA:CB:A3:12	15%(-87dbm)	36	TKIP/AES	Mixed(WPA+WPA2)/PSK
<input type="radio"/>	6	staffs_5G	00:1D:AA:04:F0:DD	5%(-90dbm)	36	AES	WPA2
<input type="radio"/>	7	DrayTek5G	00:1D:AA:80:06:C6	25%(-84dbm)	36	AES	WPA2/PSK
<input type="radio"/>	8	DrayTek-22...	00:1D:AA:04:F0:6D	15%(-87dbm)	36	TKIP/AES	Mixed(WPA+WPA2)/PSK
<input type="radio"/>	9	staffs_5G	00:1D:AA:63:2C:11	62%(-73dbm)	36	AES	WPA2
<input type="radio"/>	10	mk_carrie	06:1D:AA:3F:75:83	92%(-63dbm)	36	AES	WPA2/PSK
<input type="radio"/>	11		12:1D:AA:57:5D:39	8%(-89dbm)	36	AES	WPA2/PSK
<input type="radio"/>	12	guests	06:1D:AA:04:F0:DD	5%(-90dbm)	36	TKIP/AES	Mixed(WPA+WPA2)/PSK
<input type="radio"/>	13	DrayTek_5G	00:1D:AA:00:00:00	73%(-70dbm)	36	TKIP/AES	Mixed(WPA+WPA2)/PSK
<input type="radio"/>	14	guests	06:1D:AA:63:2C:11	62%(-73dbm)	36	TKIP/AES	Mixed(WPA+WPA2)/PSK
<input type="radio"/>	15	pqctest1	00:1D:AA:3F:4F:B3	5%(-90dbm)	36	TKIP/AES	Mixed(WPA+WPA2)/PSK
<input type="radio"/>	16		12:1D:AA:04:F0:6D	15%(-87dbm)	36	AES	WPA2/PSK
<input type="radio"/>	17	ap912c-Ban...	00:1D:AA:3F:75:83	92%(-63dbm)	36	AES	WPA2/PSK
<input type="radio"/>	18		12:1D:AA:04:F0:DD	5%(-90dbm)	36	AES	WPA2/PSK
<input type="radio"/>	19	RMA2862_FA...	00:1D:AA:7B:51:92	15%(-87dbm)	149	TKIP/AES	Mixed(WPA+WPA2)/PSK
<input type="radio"/>	20		00:1D:AA:04:F0:82	45%(-78dbm)	149	TKIP/AES	Mixed(WPA+WPA2)/PSK
<input type="radio"/>	21	Vigor2927 ...	14:49:BC:02:37:A0	4%(-91dbm)	149	AES	WPA2/PSK
<input type="radio"/>	22	PQC Justin...	00:1D:AA:F3:B9:32	22%(-85dbm)	149	TKIP/AES	Mixed(WPA+WPA2)/PSK
<input type="radio"/>	23	PQC WiFi W...	00:50:7F:F1:91:EA	28%(-83dbm)	149	AES	WPA2/PSK
<input type="radio"/>	24	DrayTek-67...	00:1D:AA:67:D6:42	5%(-90dbm)	153	AES	WPA2/PSK
<input type="radio"/>	25		12:1D:AA:57:5D:3A	11%(-88dbm)	157	AES	WPA2/PSK
<input type="radio"/>	26	DrayTek575...	00:1D:AA:57:5D:3A	11%(-88dbm)	157	TKIP/AES	Mixed(WPA+WPA2)/PSK
<input type="radio"/>	27	BX2K-PQC-5...	00:1D:AA:B0:BB:8A	4%(-91dbm)	161	TKIP/AES	Mixed(WPA+WPA2)/PSK
<input type="radio"/>	28	DrayTek-22...	00:1D:AA:04:F0:6E	25%(-84dbm)	161	TKIP/AES	Mixed(WPA+WPA2)/PSK
<input type="radio"/>	29		12:1D:AA:04:F0:6E	25%(-84dbm)	161	AES	WPA2/PSK
<input type="radio"/>	30	AP920R PQC...	00:1D:AA:63:2C:01	22%(-85dbm)	165	TKIP/AES	Mixed(WPA+WPA2)/PSK
<input type="radio"/>	31	DrayTek_5G	14:49:BC:02:37:38	3%(-92dbm)	36	NONE	
<input type="radio"/>	32	DrayTek_5G	00:1D:AA:95:B7:48	5%(-90dbm)	36	NONE	
<input type="radio"/>	33	DrayTek_5G	14:49:BC:02:38:48	8%(-89dbm)	149	NONE	

Scan

Note: During the scanning process (about 5 seconds), no station is allowed to connect with the AP.

AP's MAC Address : : : : : AP's SSID

Add to WDS Settings:

Each item is explained as follows:

Item	Description
SSID	Display the SSID of the AP scanned by VigorAP 918R.
BSSID	Display the MAC address of the AP scanned by VigorAP 918R.
RSSI	Display the signal strength of the access point. RSSI is the abbreviation of Received Signal Strength Indication.
Channel	Display the wireless channel used for the AP that is scanned by VigorAP 918R.
Encryption	Display the encryption mode for the scanned AP.
Authentication	Display the authentication type that the scanned AP applied.

Scan	It is used to discover all the connected AP. The results will be shown on the box above this button
AP's MAC Address / AP's SSID	Display the MAC address and SSID of the AP selected from the Access Point.
Add	Click it to add the AP selected from the Access Point List (with the same channel width) to the WDS Settings as peer' s setting.

II-3-7 WDS AP Status

VigorAP 918R can display the status such as MAC address, physical mode, power save and bandwidth for the working AP connected with WDS. Click **Refresh** to get the newest information.

Wireless LAN (5GHz) >> WDS AP Status

WDS AP List

AID	MAC Address	802.11 Physical Mode	Power Save	Bandwidth
-----	-------------	----------------------	------------	-----------

Refresh

It is available for wireless LAN (5GHz) only.

II-3-8 Bandwidth Management

The downstream or upstream from FTP, HTTP or some P2P applications will occupy large of bandwidth and affect the applications for other programs. Please use Bandwidth Management to make the bandwidth usage more efficient.

Wireless LAN (5GHz) >> Bandwidth Management

SSID 1	SSID 2	SSID 3	SSID 4
SSID		DrayTek-3FB230	
Per Station Bandwidth Limit			
Enable	<input checked="" type="checkbox"/>		
Upload Limit	User defined	K	bps (Default unit : K)
Download Limit	User defined	K	bps (Default unit : K)
Auto Adjustment	<input checked="" type="checkbox"/>		
Total Upload Limit	4M		bps
Total Download Limit	User defined	K	bps (Default unit : K)

Note: 1. Download : Traffic going to any station. Upload : Traffic being sent from a wireless station.
2. Allow auto adjustment could make the best utilization of available bandwidth.

OK

Cancel

Available settings are explained as follows:

Item	Description
SSID	Display the specific SSID name.
Enable	Check this box to enable the bandwidth management for clients.
Upload Limit	Define the maximum speed of the data uploading which will be used for the wireless stations connecting to Vigor device with the same SSID. Use the drop down list to choose the rate. If you choose User defined , you have to specify the rate manually.
Download Limit	Define the maximum speed of the data downloading which will be used for the wireless station connecting to Vigor device with the same SSID. Use the drop down list to choose the rate. If you choose User defined , you have to specify the rate manually.
Auto Adjustment	Check this box to have the bandwidth limit determined by the system automatically.
Total Upload Limit	When Auto Adjustment is checked, the value defined here will be treated as the total bandwidth shared by all of the wireless stations with the same SSID for data uploading.
Total Download Limit	When Auto Adjustment is checked, the value defined here will be treated as the total bandwidth shared by all of the wireless stations with the same SSID for data downloading.

After finishing this web page configuration, please click **OK** to save the settings.

II-3-9 Airtime Fairness

Airtime fairness is essential in wireless networks that must support critical enterprise applications.

Most of the applications are either symmetric or require more downlink than uplink capacity; telephony and email send the same amount of data in each direction, while video streaming and web surfing involve more traffic sent from access points to clients than the other way around. This is essential for ensuring predictable performance and quality-of-service, as well as allowing 802.11n and legacy clients to coexist on the same network. Without airtime fairness, offices using mixed mode networks risk having legacy clients slow down the entire network or letting the fastest client(s) crowd out other users.

With airtime fairness, every client at a given quality-of-service level has equal access to the network's airtime.

The wireless channel can be accessed by only one wireless station at the same time.

The principle behind the IEEE802.11 channel access mechanisms is that each station has **equal probability** to access the channel. When wireless stations have similar data rate, this principle leads to a fair result. In this case, stations get similar channel access time which is called airtime.

However, when stations have various data rate (e.g., 11g, 11n), the result is not fair. The slow stations (11g) work in their slow data rate and occupy too much airtime, whereas the fast stations (11n) become much slower.

Take the following figure as an example, both Station A(11g) and Station B(11n) transmit data packets through VigorAP 918R. Although they have equal probability to access the wireless channel, Station B(11n) gets only a little airtime and waits too much because Station A(11g) spends longer time to send one packet. In other words, Station B(fast rate) is obstructed by Station A(slow rate).

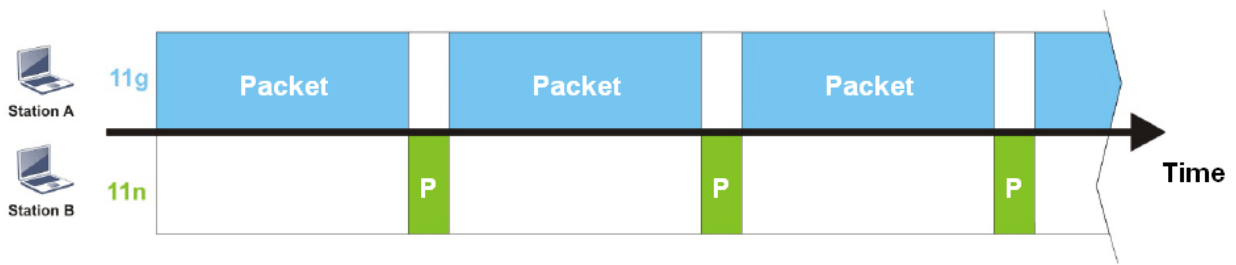

To improve this problem, Airtime Fairness is added for VigorAP 918R. Airtime Fairness function tries to assign *similar airtime* to each station (A/B) by controlling TX traffic. In the following figure, Station B(11n) has higher probability to send data packets than Station A(11g). By this way, Station B(fast rate) gets fair airtime and it's speed is not limited by Station A(slow rate).

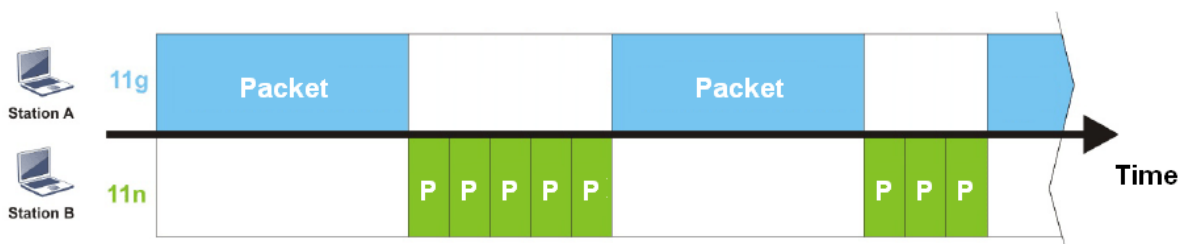

It is similar to automatic Bandwidth Limit. The dynamic bandwidth limit of each station depends on instant active station number and airtime assignment. Please note that Airtime Fairness of 2.4GHz and 5GHz are independent. But stations of different SSIDs function together, because they all use the same wireless channel. IN SPECIFIC ENVIRONMENTS, this function can reduce the bad influence of slow wireless devices and improve the overall wireless performance.

Suitable environment:

- (1) Many wireless stations.
- (2) All stations mainly use download traffic.
- (3) The performance bottleneck is wireless connection.

Wireless LAN (5GHz) >> Airtime Fairness

Enable [Airtime Fairness](#)

Triggering Client Number (2 ~ 128, Default: 2)

Note: Please enable or disable this function according to the real situation and user experience. It is NOT suitable for all environments.

Available settings are explained as follows:

Item	Description
Enable Airtime Fairness	Try to assign similar airtime to each wireless station by controlling TX traffic. Airtime Fairness – Click the link to display the following screen of airtime fairness note.

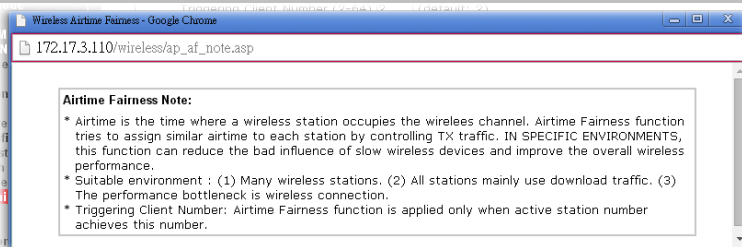

Triggering Client Number –Airtime Fairness function is applied only when active station number achieves this number.

After finishing this web page configuration, please click **OK** to save the settings.

i Note:

Airtime Fairness function and Bandwidth Limit function should be mutually exclusive. So their webs have extra actions to ensure these two functions are not enabled simultaneously.

II-3-10 Station Control

Station Control is used to specify the duration for the wireless client to connect and reconnect VigorAP. If such function is not enabled, the wireless client can connect VigorAP until it shuts down.

Such feature is especially useful for free Wi-Fi service. For example, a coffee shop offers free Wi-Fi service for its guests for one hour every day. Then, the connection time can be set as "1 hour" and reconnection time can be set as "1 day". Thus, the guest can finish his job within one hour and will not occupy the wireless network for a long time.

i Note:

Up to 300 Wireless Station records are supported by VigorAP.

Wireless LAN (5GHz) >> Station Control

SSID 1	SSID 2	SSID 3	SSID 4
SSID	DrayTek-3FB230		
Enable	<input type="checkbox"/>		
Connection Time	1 hour ▾		
Reconnection Time	1 day ▾		
Display All Station Control List			

Note: Once the feature is enabled, the connection time quota will apply to each wireless client (identified by MAC address).

Available settings are explained as follows:

Item	Description
SSID	Display the SSID that the wireless station will use it to connect with Vigor router.
Enable	Check the box to enable the station control function.
Connection Time / Reconnection Time	Use the drop down list to choose the duration for the wireless client connecting /reconnecting to Vigor device. Or, type the duration manually when you choose User defined .
Display All Station Control List	All the wireless stations connecting to Vigor router by using such SSID will be listed on Station Control List.

After finishing all the settings here, please click **OK** to save the configuration.

II-3-11 Roaming

The network signal for a single wireless access point might be limited by its coverage range. Therefore, if you want to expand the wireless network in a large exhibition with a quick method, you can install multiple access points with enabling the Roaming feature for each AP to reach the purpose of expanding wireless signals seamlessly.

These access points connecting for each other shall be verified by pre-authentication. This page allows you to enable the roaming feature and the pre-authentication.

Wireless LAN (5GHz) >> Roaming

AP-assisted Client Roaming Parameters

<input type="checkbox"/> Minimum Basic Rate	6	Mbps
<input checked="" type="radio"/> Disable RSSI Requirement		
<input type="radio"/> Strictly Minimum RSSI	-73	dBm (42 %) (Default: -73)
<input type="radio"/> Minimum RSSI	-66	dBm (60 %) (Default: -66)
with Adjacent AP RSSI over	5	dB (Default: 5)

Fast Roaming(WPA2/802.1x)

<input type="checkbox"/> Enable	
PMK Caching : Cache Period	10 minutes (10 ~ 600, Default: 10)
Pre-Authentication	

OK Cancel

Available settings are explained as follows:

Item	Description
AP-assisted Client Roaming Parameters	<p>When the link rate of wireless station is too low or the signal received by the wireless station is too worse, VigorAP 918R will automatically detect (based on the link rate and RSSI requirement) and cut off the network connection for that wireless station to assist it to connect another Wireless AP to get better signal.</p> <p>Minimum Basic Rate - Check the box to use the drop down list to specify a basic rate (Mbps). When the link rate of the wireless station is below such value, VigorAP 918R will terminate the network connection for that wireless station.</p> <p>Disable RSSI Requirement - If it is selected, VigorAP will not terminate the network connection based on RSSI.</p> <p>Strictly Minimum RSSI - VigorAP uses RSSI (received signal strength indicator) to decide to terminate the network connection of wireless station. When the signal strength is below the value (dBm) set here, VigorAP 918R will terminate the network connection for that wireless station.</p> <p>Minimum RSSI - When the signal strength of the wireless station is below the value (dBm) set here and adjacent AP (must be DrayTek AP and support such feature too) with higher signal strength value (defined in the field of With Adjacent AP RSSI over) is detected by VigorAP 918R, VigorAP 918R will terminate the network connection for</p>

	<p>that wireless station. Later, the wireless station can connect to the adjacent AP (with better RSSI).</p> <ul style="list-style-type: none"> ● With Adjacent AP RSSI over – Specify a value as a threshold.
<p>Fast Roaming (WPA2/802.1x)</p>	<p>Enable – Check the box to enable fast roaming configuration.</p> <p>PMK Caching - Set the expire time of WPA2 PMK (Pairwise master key) cache. PMK Cache manages the list from the BSSIDs in the associated SSID with which it has pre-authenticated. Such feature is available for WPA2/802.1 mode.</p> <p>Pre-Authentication - Enables a station to authenticate to multiple APs for roaming securer and faster. With the pre-authentication procedure defined in IEEE 802.11i specification, the pre-four-way-handshake can reduce handoff delay perceivable by a mobile node. It makes roaming faster and more secure. (Only valid in WPA2)</p> <p>Enable - Enable IEEE 802.1X Pre-Authentication.</p> <p>Disable - Disable IEEE 802.1X Pre-Authentication.</p>

After finishing this web page configuration, please click **OK** to save the settings.

II-3-12 Band Steering (for Wireless LAN (2.4GHz))

Band Steering detects if the wireless clients are capable of 5GHz operation, and steers them to that frequency. It helps to leave 2.4GHz band available for legacy clients, and improves users experience by reducing channel utilization.

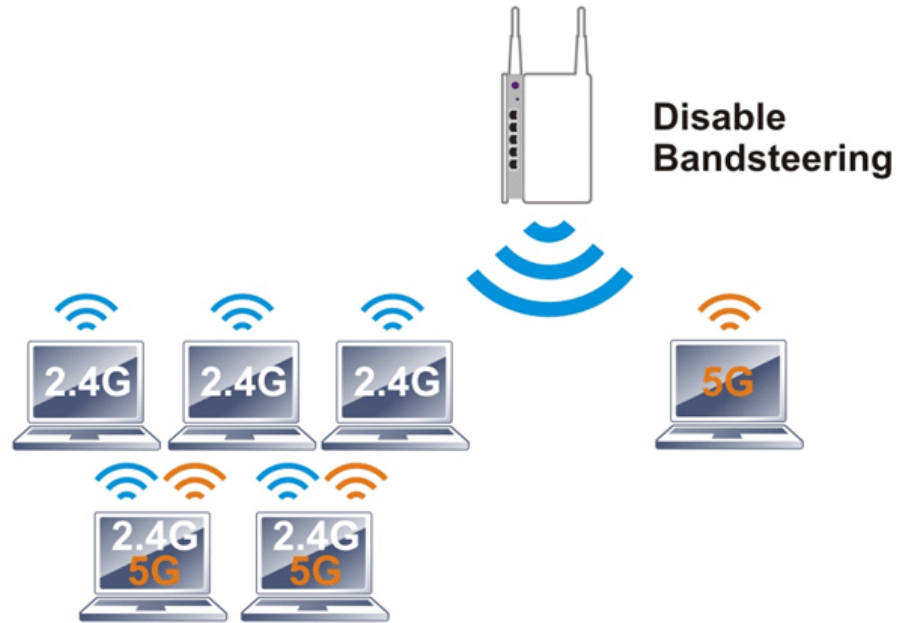

If dual-band is detected, the AP will let the wireless client connect to less congested wireless LAN, such as 5GHz to prevent from network congestion.

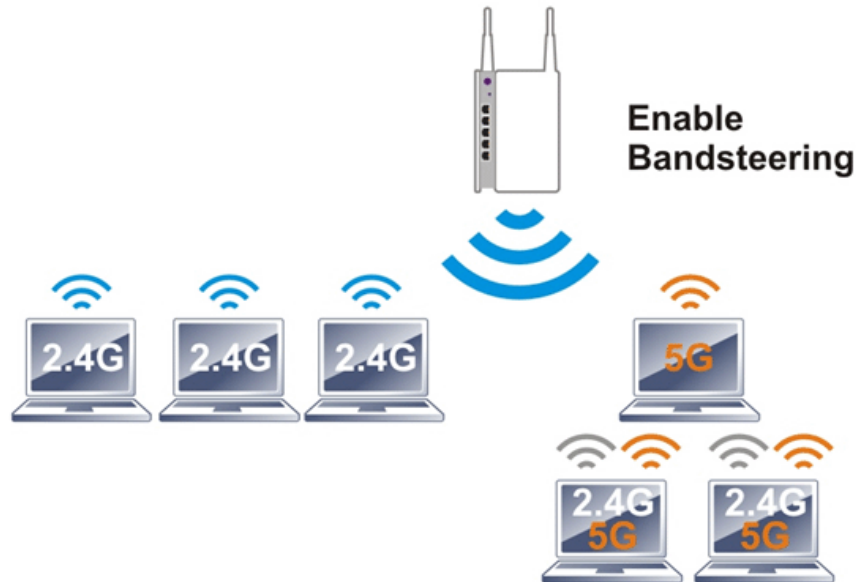

i Note:

To make Band Steering work successfully, SSID and security on 2.4GHz also MUST be broadcasted on 5GHz.

Open **Wireless LAN (2.4GHz)>>Band Steering** to get the following web page:

Wireless LAN (2.4GHz) >> Band Steering

Enable [Band Steering](#)

Check Time for WLAN Client 5G Capability seconds (1 ~ 60, Default: 15)

Wait Full Time to Check 5G Capability

5GHz Minimum RSSI dBm (%) (Default: -78)
(Only do band steering when 5GHz signal is better than Minimum RSSI)

Overloaded

2.4GHz Utilization Overload Threshold % (Default: 70)

5GHz Utilization Overload Threshold % (Default: 70)
(Only do band steering when 2.4GHz utilization is overloaded and 5GHz utilization is not)

Note: Please setup at least one pair of 2.4GHz and 5GHz Wireless LAN with the same SSID and security.

Available settings are explained as follows:

Item	Description
Enable Band Steering	<p>If it is enabled, VigorAP will detect if the wireless client is capable of dual-band or not within the time limit.</p> <p>Check Time.... – If the wireless station does not have the capability of 5GHz network connection, the system shall wait and check for several seconds (15 seconds, in default) to make the 2.4GHz network connection. Specify the time limit for VigorAP to detect the wireless client.</p> <p>Wait Full Time to Check 5G Capability – If enabled, the client trying to connect to wireless network 2.4G has to wait for a few seconds (defined in Check Time... above) to check if the connecting device has the 5G capability. If no 5G capability, the client will be directed to the wireless 2.4G network.</p> <p>5GHz Minimum RSSI – The wireless station has the capability of 5GHz network connection, yet the signal performance might not be satisfied. Therefore, when the signal strength is below the value set here while the wireless station connecting to VigorAP 920RP, VigorAP will allow the client to connect to 2.4GHz network.</p> <p>Overloaded – If it is enabled, VigorAP will activate the band steering according to the conditions set below.</p> <ul style="list-style-type: none"> ● 2.4GHz Utilization Overload Threshold – The default setting is 70%. It can define the network congestion for 2.4GHz. ● 5GHz Utilization Overload Threshold – The default setting is 70%. It can define the network congestion for 5GHz. <p>When the utilization of 2.4GHz is higher than the specified threshold and the utilization of 5GHz is lower than the specified threshold, VigorAP will steer the client to connect to 5GHz network.</p>

After finishing this web page configuration, please click **OK** to save the settings.

Below shows how Band Steering works.

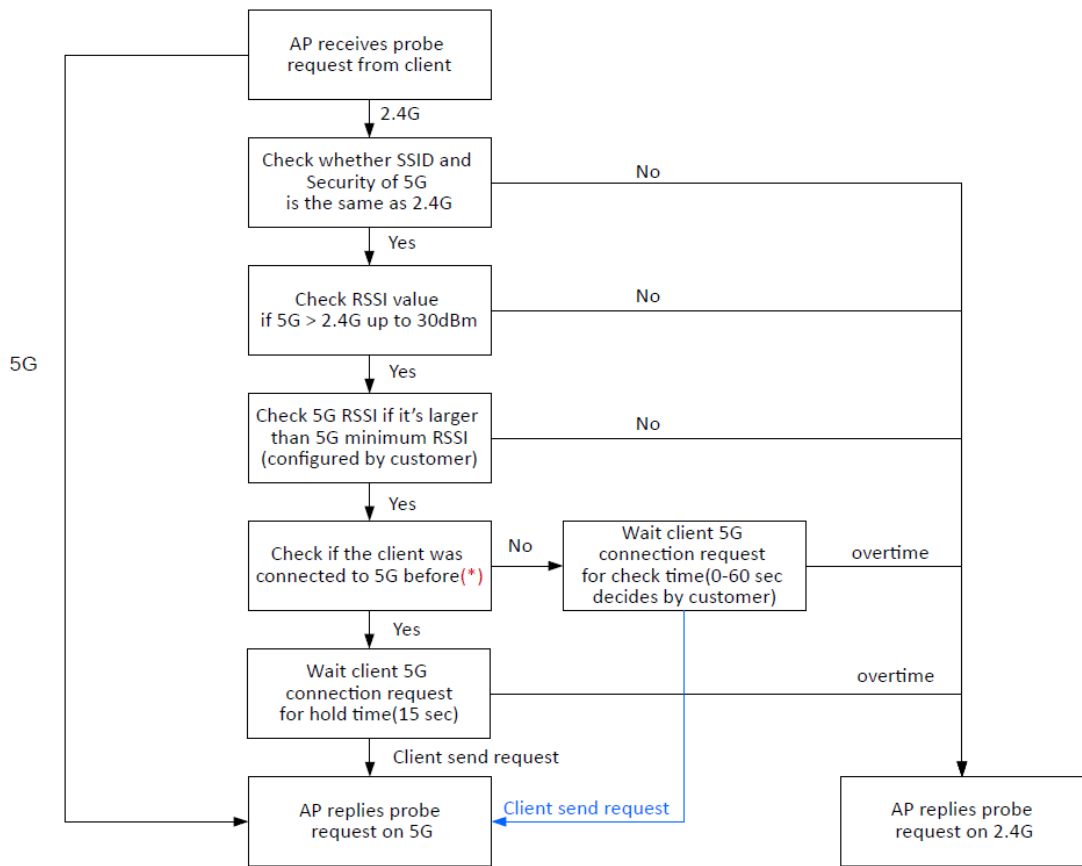

* AP will clear the 5G history station list every 2.5 mins.

How to Use Band Steering?

1. Open **Wireless LAN(2.4GHz)>>Band Steering**.
2. Check the box of **Enable Band Steering** and use the default value (15) for check time setting.

Wireless LAN (2.4GHz) >> Band Steering

Enable **Band Steering**

Check Time for WLAN Client 5G Capability seconds (1 ~ 60, Default: 15)

Wait Full Time to Check 5G Capability

3. Click **OK** to save the settings.
4. Open **Wireless LAN (2.4GHz)>>General Setup** and **Wireless LAN (5GHz)>> General Setup**. Configure SSID as *ap918r-BandSteering* for both pages. Click **OK** to save the settings.

Wireless LAN (2.4GHz) >> General Setup

General Setting (IEEE 802.11)

Enable Wireless LAN

Enable Client Limit (3 ~ 128, default: 128)

Enable Client Limit per SSID (3 ~ 128, default: 128)

Mode :

Channel :

Extension Channel :

	Enable	Hide SSID	SSID	Isolate LAN	Isolate Member	VLAN ID (0:Untagged)
1	<input type="checkbox"/>	<input type="checkbox"/>	ap918r-BandSteering	<input type="checkbox"/>	<input type="checkbox"/>	<input type="text" value="0"/>
2	<input checked="" type="checkbox"/>	<input type="checkbox"/>	mk_carrie	<input type="checkbox"/>	<input type="checkbox"/>	<input type="text" value="0"/>

Wireless LAN (5GHz) >> General Setup

General Setting (IEEE 802.11)

Enable Wireless LAN

Enable Client Limit (3 ~ 128, default: 128)

Enable Client Limit per SSID (3 ~ 128, default: 128)

Mode :

Channel : (Active Channel: 36) [Filtered Out List](#)

Details : 20/40MHz Ext Ch: 40 , 80MHz Center Ch: 42

	Enable	Hide SSID	SSID	Isolate LAN	Isolate Member	VLAN ID (0:Untagged)
1	<input type="checkbox"/>	<input type="checkbox"/>	ap918r-BandSteering	<input type="checkbox"/>	<input type="checkbox"/>	<input type="text" value="0"/>
2	<input checked="" type="checkbox"/>	<input type="checkbox"/>	mk_carrie	<input type="checkbox"/>	<input type="checkbox"/>	<input type="text" value="0"/>

Same value for 2.4GHz and 5GHz

5. Open **Wireless LAN (2.4GHz)>>Security** and **Wireless LAN (5GHz)>>Security**. Configure Security as 12345678 for both pages. Click **OK** to save the settings.

Wireless LAN (2.4GHz) >> Security Settings

SSID 1	SSID 2	SSID 3	SSID 4
SSID			
DrayTek-3FB230			
Mode			
WPA2/PSK			
Set up RADIUS Server if 802.1x is enabled.			
WPA			
WPA Algorithms			
<input type="radio"/> TKIP <input checked="" type="radio"/> AES <input type="radio"/> TKIP/AES			
Pass Phrase			
.....			
Key Renewal Interval			
3600 seconds			
EAPOL Key Retry			
<input checked="" type="radio"/> Enable <input type="radio"/> Disable			

Wireless LAN (5GHz) >> Security Settings

SSID 1	SSID 2	SSID 3	SSID 4
SSID			
DrayTek-3FB230			
Mode			
WPA2/PSK			
Set up RADIUS Server if 802.1x is enabled.			
WPA			
WPA Algorithms			
<input type="radio"/> TKIP <input checked="" type="radio"/> AES <input type="radio"/> TKIP/AES			
Pass Phrase			
.....			
Key Renewal Interval			
3600 seconds			
EAPOL Key Retry			
<input checked="" type="radio"/> Enable <input type="radio"/> Disable			

Same value
for 2.4GHz
and 5GHz

6. Now, VigorAP 918R will let the wireless clients connect to less congested wireless LAN, such as 5GHz to prevent from network congestion.

II-3-13 Station List

Station List provides the information related to the number of clients connecting to VigorAP, used bandwidth and the statistics of the AP device OS. Besides, users can create access control policies, device objects and set black & white list for

II-3-13-1 Connected Number

This page lists the graph for the number of wireless stations connected to this Access Point with different time phases.

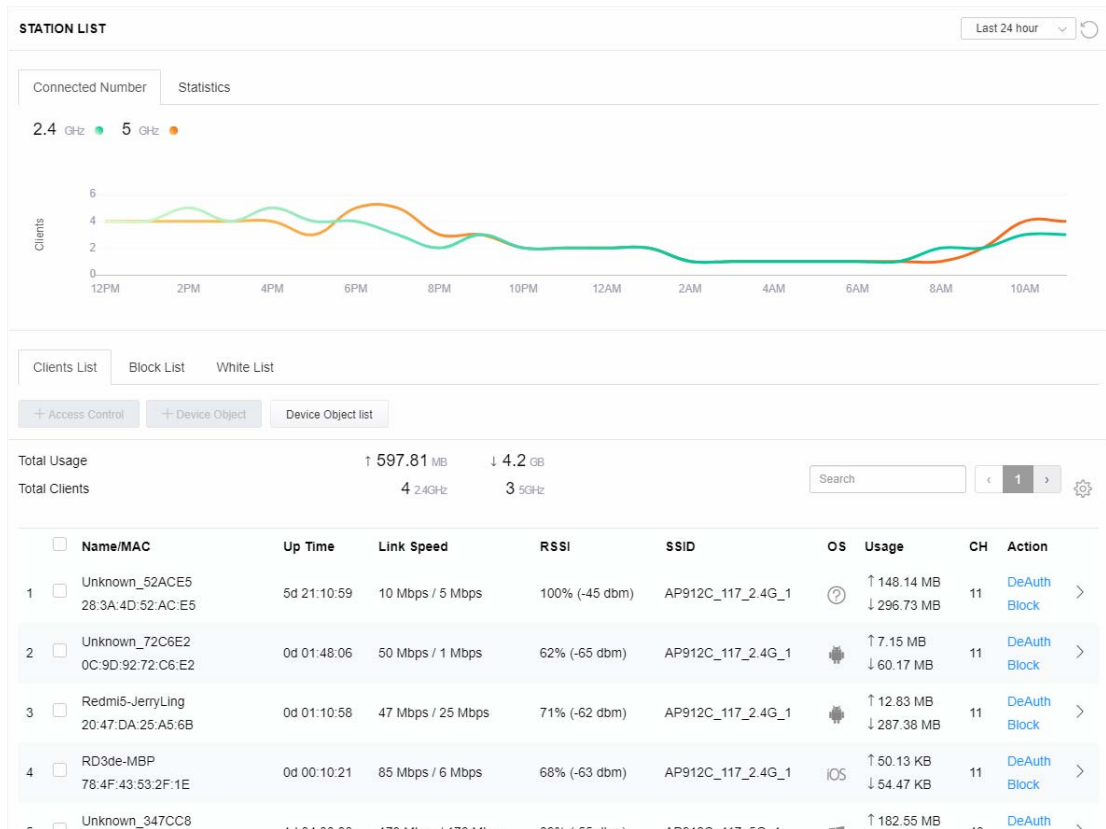

II-3-13-2 Statistics

The number of detected devices and the number of device(s) passed/blocked according to the policy specified in **Mobile Device Management>>Policy** can be illustrated as doughnut chart.

Connected Number

Statistics



0% Android 0
 0% iOS 0
 0% Windows 0
 0% Linux 0
 100% Others 58



100% Pass 58
 0% Block 0

Clients List

Block List

White List

+ Access Control

+ Device Object

Device Object list

Total Usage

↑ 58.13 KB ↓ 45.89 KB

Total Clients

0 2.4GHz 64 5GHz

5g

< 1 2 3 4 5 6 7 >

<input type="checkbox"/>	Name/MAC	Up Time	Link Speed	RSSI	SSID	OS	Usage	CH	Action
1	<input type="checkbox"/> Unknown_C84A46 00:BC:DA:C8:4A:46	0d 03:41:17	270 Mbps / 6 Mbps	57% (-67 dbm)	AA-903	?	↑ 867 B ↓ 717 B	36	DeAuth Block
2	<input type="checkbox"/> Unknown_07B0C1 00:BC:DA:07:B0:C1	0d 03:41:17	270 Mbps / 6 Mbps	55% (-68 dbm)	AA-903	?	↑ 867 B ↓ 717 B	36	DeAuth Block
3	<input type="checkbox"/> Unknown_C34F0A 00:BC:DA:C3:4F:0A	0d 03:41:17	270 Mbps / 6 Mbps	57% (-67 dbm)	AA-903	?	↑ 867 B ↓ 717 B	36	DeAuth Block
4	<input type="checkbox"/> Unknown_0CEEE9 00:BC:DA:0C:EE:E9	0d 03:41:16	270 Mbps / 6 Mbps	62% (-65 dbm)	AA-903	?	↑ 867 B ↓ 717 B	36	DeAuth Block
5	<input type="checkbox"/> Unknown_607C8F 00:BC:DA:60:7C:8F	0d 03:41:16	270 Mbps / 6 Mbps	57% (-67 dbm)	AA-903	?	↑ 867 B ↓ 717 B	36	DeAuth Block
6	<input type="checkbox"/> Unknown_9D28C0 00:BC:DA:9D:28:C0	0d 03:41:46	270 Mbps / 6 Mbps	55% (-68 dbm)	AA-903	?	↑ 867 B ↓ 717 B	36	DeAuth Block
7	<input type="checkbox"/> Unknown_79E9C2 00:BC:DA:79:E9:C2	0d 03:41:46	270 Mbps / 6 Mbps	57% (-67 dbm)	AA-903	?	↑ 867 B ↓ 717 B	36	DeAuth Block
8	<input type="checkbox"/> Unknown_9B07CE 00:BC:DA:9B:07:CE	0d 03:41:46	270 Mbps / 6 Mbps	55% (-68 dbm)	AA-903	?	↑ 867 B ↓ 717 B	36	DeAuth Block
9	<input type="checkbox"/> Unknown_AA5A63 00:BC:DA:AA:5A:63	0d 03:41:46	270 Mbps / 6 Mbps	55% (-68 dbm)	AA-903	?	↑ 867 B ↓ 717 B	36	DeAuth Block
10	<input type="checkbox"/> Unknown_DD1FA2 00:BC:DA:DD:1F:A2	0d 03:41:46	270 Mbps / 6 Mbps	57% (-67 dbm)	AA-903	?	↑ 903 B ↓ 717 B	36	DeAuth Block

II-3-13-3 Clients List

The client list displays all the stations connecting to VigorAP.

STATION LIST ⓘ Last 24 hour ↻

Connected Number Statistics

Device OS

- 0% Android 0
- 0% iOS 0
- 0% Windows 0
- 0% Linux 0
- 100% Others 58

Policy

- 100% Pass 58
- 0% Block 0

Clients List Block List White List

+ Access Control + Device Object Device Object list

Total Usage ↑ 58.13 KB ↓ 45.89 KB

Total Clients 0 2.4GHz 64 5GHz 5g < 1 2 3 4 5 6 7 > ⚙️

<input type="checkbox"/>	Name/MAC	Up Time	Link Speed	RSSI	SSID	OS	Usage	CH	Action
<input type="checkbox"/>	Unknown_C84A46 00:BC:DA:C8:4A:46	0d 03:42:47	270 Mbps / 6 Mbps	57% (-67 dbm)	AA-903	?	↑ 867 B ↓ 717 B	36	DeAuth Block
<input checked="" type="checkbox"/>	Unknown_07B0C1 00:BC:DA:07:B0:C1	0d 03:42:47	270 Mbps / 6 Mbps	55% (-68 dbm)	AA-903	?	↑ 867 B ↓ 717 B	36	DeAuth Block
<input checked="" type="checkbox"/>	Unknown_C34F0A 00:BC:DA:C3:4F:0A	0d 03:42:47	270 Mbps / 6 Mbps	57% (-67 dbm)	AA-903	?	↑ 867 B ↓ 717 B	36	DeAuth Block
<input type="checkbox"/>	Unknown_0CEEE9 00:BC:DA:0C:EE:E9	0d 03:42:46	270 Mbps / 6 Mbps	62% (-65 dbm)	AA-903	?	↑ 867 B ↓ 717 B	36	DeAuth Block

Available settings are explained as follows:

Item	Description									
+Access Control	<p>It is available after choosing one of the entries (clients) on Clients List.</p> <div style="border: 1px solid #ccc; padding: 10px; margin: 10px 0;"> <p>Add Access Control</p> <p>Wireless LAN 5GHz</p> <hr/> <p>SSID Policy</p> <p>1 Black list 2 Disable 3 Disable 4 Disable</p> <p style="font-size: small; margin-left: 20px;">AA-903 AA-903-2 AA-903-3 AA-903-4</p> <hr/> <p>From to list</p> <table style="width: 100%; border-collapse: collapse;"> <thead> <tr> <th style="width: 20%;">Device MAC</th> <th style="width: 30%;">Name</th> <th style="width: 50%;">Apply to SSID</th> </tr> </thead> <tbody> <tr> <td>00:BC:DA:07:B0:C1</td> <td>Unknown_07B0C1</td> <td><input type="checkbox"/> All <input type="checkbox"/> 1 <input type="checkbox"/> 2 <input type="checkbox"/> 3 <input type="checkbox"/> 4</td> </tr> <tr> <td>00:BC:DA:C3:4F:0A</td> <td>Unknown_C34F0A</td> <td><input type="checkbox"/> All <input type="checkbox"/> 1 <input type="checkbox"/> 2 <input type="checkbox"/> 3 <input type="checkbox"/> 4</td> </tr> </tbody> </table> <p style="font-size: small; margin-top: 5px;">Total : 0/256</p> <p style="text-align: right;">Close Save changes</p> </div> <p>Wireless LAN - Specify the bandwidth for the access control list.</p> <p>SSID Policy - Set the policy for each SSID as black list or white list or disable.</p> <p>From to list - Display the clients available for applying this access</p>	Device MAC	Name	Apply to SSID	00:BC:DA:07:B0:C1	Unknown_07B0C1	<input type="checkbox"/> All <input type="checkbox"/> 1 <input type="checkbox"/> 2 <input type="checkbox"/> 3 <input type="checkbox"/> 4	00:BC:DA:C3:4F:0A	Unknown_C34F0A	<input type="checkbox"/> All <input type="checkbox"/> 1 <input type="checkbox"/> 2 <input type="checkbox"/> 3 <input type="checkbox"/> 4
Device MAC	Name	Apply to SSID								
00:BC:DA:07:B0:C1	Unknown_07B0C1	<input type="checkbox"/> All <input type="checkbox"/> 1 <input type="checkbox"/> 2 <input type="checkbox"/> 3 <input type="checkbox"/> 4								
00:BC:DA:C3:4F:0A	Unknown_C34F0A	<input type="checkbox"/> All <input type="checkbox"/> 1 <input type="checkbox"/> 2 <input type="checkbox"/> 3 <input type="checkbox"/> 4								

control.

Apply to SSID - Check **All** to make the device apply the policies to all SSIDs. Or select the one(s) to make the device apply the policies to the selected SSIDs.

Close - Exit this page without saving any changes.

Save changes - Save the changes and exit this page.

+Device Object

To add a device to device object list, choose one of the entries (clients) on Clients List to enable the Device Object button. Click the button to open the following page.

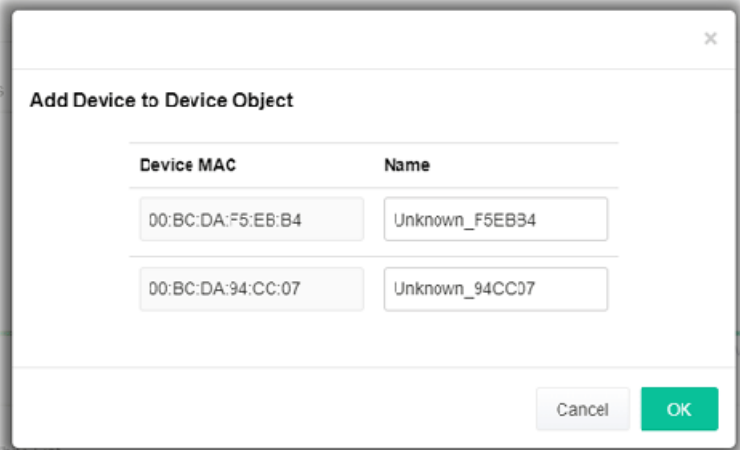

The screenshot shows a dialog box titled "Add Device to Device Object". It contains two rows of input fields. The first row has "Device MAC" as "00:BC:DA:F5:E6:B4" and "Name" as "Unknown_F5EB34". The second row has "Device MAC" as "00:BC:DA:94:CC:07" and "Name" as "Unknown_94CC07". At the bottom right, there are "Cancel" and "OK" buttons.

Check the information listed on the page. Change the MAC address or name of the selected entry if required. Then click **OK** and exit the page.

Device Object list

The existed device object profiles will be shown on the following page.



The screenshot shows a page titled "DEVICE OBJECT" with a section "Device Object Profiles". There is a search bar and a "Set to Factory Default" button. Below is a table with the following data:

Profile	MAC	Name
1	00:50:7F:F1:91:BC	TEST_1
2	00:50:7F:00:52:BA	TEST_2

Clients List

Display the stations connecting to this Vigor device.

Total Usage - Display

Total Clients - Display the number of the clients using 2.4GHz

Name / MAC - Display the host name / MAC address of the connecting client.

Up Time - Display the connection time.

Link Speed- Display the link speed.

RSSI - Display the RSSI value.

SSID - Display the SSID the client used for connecting VigorAP.

OS - Display the OS of the client.

Usage - Display the bandwidth usage (up and down) of the client.

CH - Display the channel used by the client.

Action - Display the authentication method used by the client, and if it is on block list or white list.

II-3-13-4 Block List

This page displays information of the stations under block list.

STATION LIST ⓘ Last 24 hour ↻

Connected Number Statistics

2.4 GHz ● 5 GHz ●

Clients List Block List White List

+ Access Control + Device Object Device Object list

Search ⚙

< 1 >

	Name / MAC	SSID	Reason	Action
1	Unknown_457823 00:BC:DB:45:78:23	AA-903	ACL	Unblock
2	Unknown_A566C8 00:BC:DB:A5:66:C8	AA-903	ACL	Unblock

Total list 2

Available settings are explained as follows:

Item	Description
Device Object list	Click it to open the Device Object List dialog for reference. 
Name / MAC	Display the host name / MAC Address for the connecting client.
SSID	Display the SSID that the wireless client connects to.
Reason	Display the reference information.
Action	Display the action that you can execute for the station. Unblock - Click to unblock the entry.

II-3-13-5 White List

This page displays general information of the stations under white list.

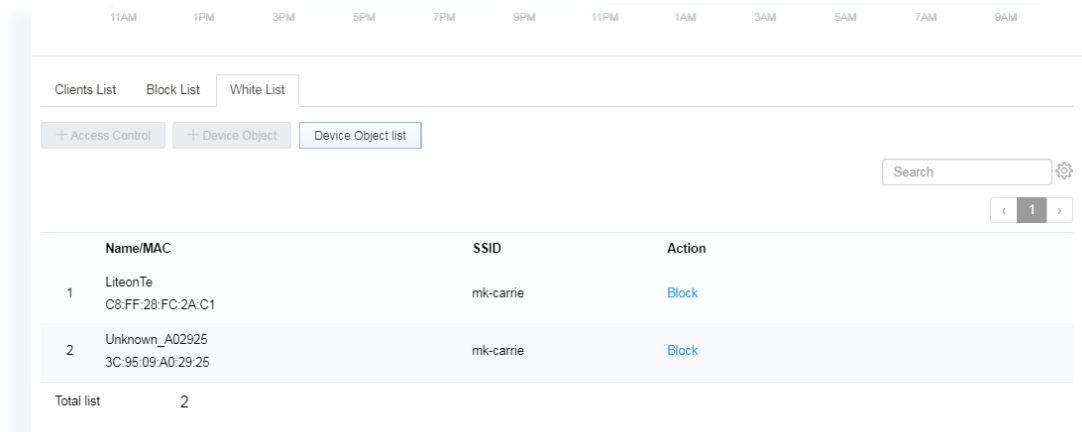

Available settings are explained as follows:

Item	Description
Device Object list	Click it to open the Device Object List dialog for reference. 
Name / MAC	Display the host name / MAC Address for the connecting client.
SSID	Display the SSID that the wireless client connects to.
Action	Display the action that you can execute for the station. Block - Click to block the entry.

II-4 Mesh Settings for Mesh Mode

When you choose **Mesh** as the operation mode, the Mesh menu with the settings of Mesh Setup, Mesh Status, Mesh Discovery and Configuration Sync will be shown on the screen.



Please note that, within VigorMesh network,

- the total number allowed for mesh nodes is 8 (including the mesh root)
- the maximum number of hop is 3

Refer to the following figure:

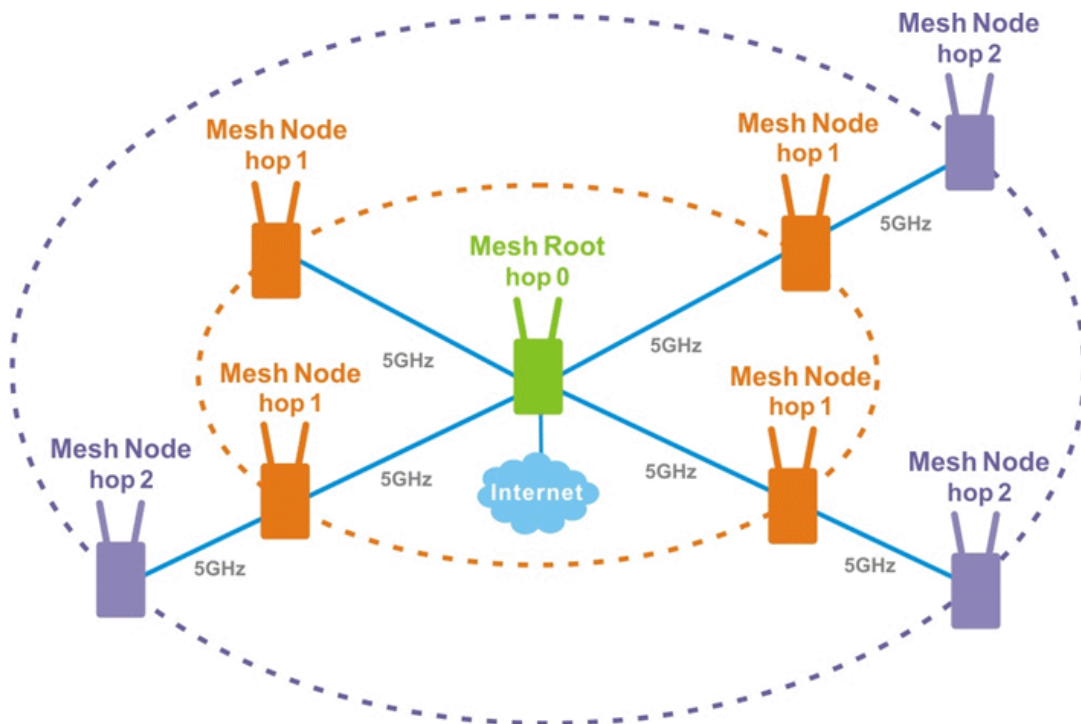

For the mesh group set within VigorMesh network,

- It must be composed by "1" Mesh Root and "0-7" mesh nodes
- (Roaming) Normally members in a mesh group use the same Wireless SSID/security
- (Add) Only the mesh root can add a new mesh node into the mesh group
- (Recover) A disconnected mesh node will automatically try to connect to another connected mesh node of the same group

Mesh Root and Mesh Node

Mesh Root indicates that VigorAP would be other AP's uplink connection. As a Mesh Root, VigorAP must connect to a gateway with Ethernet cable first to have an internet connection.

As a Mesh Node, VigorAP can connect to the mesh root or mesh node within the same mesh group via wireless network or physical connection with an Ethernet cable.

The following figure shows how VigorAP runs as MESH ROOT:

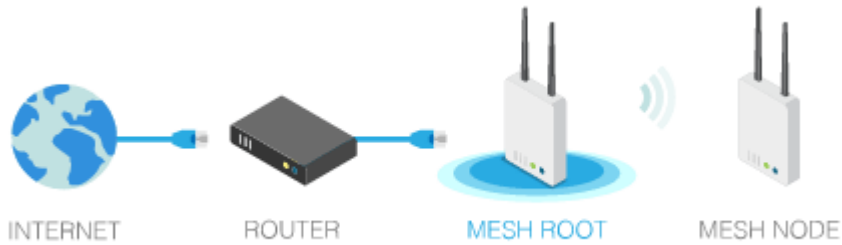

The following figure shows how VigorAP runs as MESH NODE:



II-4-1 Mesh Setup

Such page can determine the role of the VigorAP connecting to the computer physically. For a mesh root, you can search and specify mesh nodes as members under current mesh group.

Mesh >> Mesh Setup

General Setup

Role Mesh Root Mesh Node

Group Name

Log Level

Mesh Group

Select	Index	Role	MAC Address	Model
<input type="checkbox"/>	1	Root	00:1D:AA:3F:B2:30	VigorAP918R

Add Mesh Node

Press Search button below to find and adopt the new node into Mesh group.

Backup Mesh Config

Available settings are explained as follows:

Item	Description
Role	<p>Mesh Root – When VigorAP is connected to a Vigor router with a physical Ethernet cable, it can be set as mesh root to deliver the wireless signals to a mesh node AP.</p> <p>Mesh Node – As a mesh node, such VigorAP can pass the wireless connection signal to other mesh node or a remote device (PC, CPE, mobile phone).</p> <p>In addition, VigorAP can be searched by mesh root AP and join the mesh group of the root AP. The configuration set for mesh root can be applied to mesh node.</p> <p>Group Name - Display the name of the current mesh group.</p>
When Mesh Root is selected	<p>Log Level – Choose Basic or Detailed. Related information will be shown on the Diagnostics>>System Log.</p>
When Mesh Node is selected	<p>Wired Uplink – Check the box if such VigorAP connects to an uplinked mesh root or an uplinked mesh node with an Ethernet cable.</p> <p>Wireless Uplink Band – Choose a wireless band for connecting with an uplinked mesh root or an uplinked mesh node.</p> <p>Log Level – Choose Basic or Detailed. Related information will be shown on the Diagnostics>>System Log.</p>
Mesh Group	<p>When the VigorAP is set as mesh root or is added to a mesh group, the basic information including role, MAC address, and model name of the AP will be shown in this area.</p>

	<p>Up to 8 entries (one mesh root and seven mesh nodes) will be shown on this field.</p> <p>Reset - Click it to clear the Mesh Group information.</p> <p>Delete - Click it to remove the selected entry.</p>										
<p>Add Mesh Node</p>	<p>Click Search to find out available mesh node on the network.</p> <div data-bbox="651 412 1406 629" style="border: 1px solid #ccc; padding: 5px;"> <p>Add Mesh Node</p> <p>Press Search button below to find and adopt the new node into Mesh group.</p> <p style="text-align: center;"><input type="button" value="Search"/></p> <p>Search List</p> <table border="1" data-bbox="660 528 1399 591"> <thead> <tr> <th>Select</th> <th>MAC Address</th> <th>Model</th> <th>Operation Mode</th> <th>Device Name</th> </tr> </thead> <tbody> <tr> <td style="text-align: center;"><input type="checkbox"/></td> <td>00:1D:AA:22:33:08</td> <td>VigorAP903</td> <td>MeshNode(Wireless)</td> <td><input type="text"/></td> </tr> </tbody> </table> <p style="text-align: center;"><input type="button" value="Apply"/></p> </div> <p>Check the one you want and click Apply. The selected AP will be added onto current mesh root.</p>	Select	MAC Address	Model	Operation Mode	Device Name	<input type="checkbox"/>	00:1D:AA:22:33:08	VigorAP903	MeshNode(Wireless)	<input type="text"/>
Select	MAC Address	Model	Operation Mode	Device Name							
<input type="checkbox"/>	00:1D:AA:22:33:08	VigorAP903	MeshNode(Wireless)	<input type="text"/>							
<p>Backup Mesh Config</p>	<p>Backup – Click the button to save the configuration as a file.</p> <p>Upload/Restore – Click the Upload button to specify a configuration file. Then click Restore to apply the configuration.</p> <p>When the MAC address of such VigorAP does not appear under the mesh group, the restore operation will not succeed and the error message, "Device MAC is not in mesh group list", will be shown instead.</p>										

How to set up a mesh group?

The following steps will guide you how to setup a Mesh Group (with mesh root and mesh node) from **Mesh >> Mesh Setup**.

1. Open **Mesh>>Mesh Setup**. Click **Mesh Root** and click **OK** for the VigorAP connected to PC with Ethernet cable. At first, a Mesh Group is with only Mesh Root.

Mesh >> Mesh Setup

General Setup

Role Mesh Root Mesh Node

Group Name

Log Level

Mesh Group

Select	Index	Role	MAC Address	Model
	1	Root	00:1D:AA:3F:B2:30	VigorAP918R

Add Mesh Node

Press Search button below to find and adopt the new node into Mesh group.

Backup Mesh Config

...

2. Click the **Search** button in the field of **Add Mesh Node**.

Mesh Group

Select	Index	Role	MAC Address	Model
	1	Root	00:1D:AA:3F:B2:30	VigorAP918R

Add Mesh Node

Press Search button below to find and adopt the new node into Mesh group.

Backup Mesh Config

...

- Wait until the searching result appears.

Add Mesh Node

Press Search button below to find and adopt the new node into Mesh group.

Search List

Select	MAC Address	Model	Operation Mode	Device Name
<input type="checkbox"/>	00:50:7F:F1:7E:EA	VigorAP918R	MeshNode(Wireless)	<input type="text"/>
<input type="checkbox"/>	00:1D:AA:04:F0:10	VigorAP1000C	MeshNode(Wireless)	<input type="text"/>
<input type="checkbox"/>	00:1D:AA:32:BC:24	VigorAP918RPD	MeshNode(Wired)	<input type="text"/>
<input type="checkbox"/>	00:1D:AA:78:C9:20	VigorAP920R	MeshNode(Wireless)	<input type="text"/>
<input type="checkbox"/>	00:1D:AA:78:CF:B0	VigorAP920R	MeshNode(Wireless)	<input type="text"/>
<input type="checkbox"/>	00:1D:AA:68:D6:18	VigorAP920RPD	MeshNode(Wired)	<input type="text"/>

Backup Mesh Config

- Choose the device(s) you want to add to the Mesh Group as mesh node(s) and define the **Device Name** for each node. In this example, five devices are specified as mesh nodes.

Add Mesh Node

Press Search button below to find and adopt the new node into Mesh group.

Search List

Select	MAC Address	Model	Operation Mode	Device Name
<input checked="" type="checkbox"/>	00:50:7F:F1:7E:EA	VigorAP918R	MeshNode(Wireless)	<input type="text" value="room1"/>
<input checked="" type="checkbox"/>	00:1D:AA:04:F0:10	VigorAP1000C	MeshNode(Wireless)	<input type="text" value="room2"/>
<input type="checkbox"/>	00:1D:AA:32:BC:24	VigorAP918RPD	MeshNode(Wired)	<input type="text"/>
<input checked="" type="checkbox"/>	00:1D:AA:78:C9:20	VigorAP920R	MeshNode(Wireless)	<input type="text" value="room3"/>
<input checked="" type="checkbox"/>	00:1D:AA:78:CF:B0	VigorAP920R	MeshNode(Wireless)	<input type="text" value="room4"/>
<input checked="" type="checkbox"/>	00:1D:AA:68:D6:18	VigorAP920RPD	MeshNode(Wired)	<input type="text" value="room5"/>

Backup Mesh Config

- Click the **Apply** button and wait for it to finish the procedure.

Add Mesh Node

Press Search button below to find and adopt the new node into Mesh group.

Search List

Select	MAC Address	Model	Operation Mode	Device Name
<input checked="" type="checkbox"/>	00:50:7F:F1:7E:EA	VigorAP918R	MeshNode(Wireless)	<input type="text" value="room1"/>
<input checked="" type="checkbox"/>	00:1D:AA:04:F0:10	VigorAP1000C	MeshNode(Wireless)	<input type="text" value="room2"/>
<input type="checkbox"/>	00:1D:AA:32:BC:24	VigorAP918RPD	MeshNode(Wired)	<input type="text"/>
<input checked="" type="checkbox"/>	00:1D:AA:78:C9:20	VigorAP920R	MeshNode(Wireless)	<input type="text" value="room3"/>
<input checked="" type="checkbox"/>	00:1D:AA:78:CF:B0	VigorAP920R	MeshNode(Wireless)	<input type="text" value="room4"/>
<input checked="" type="checkbox"/>	00:1D:AA:68:D6:18	VigorAP920RPD	MeshNode(Wired)	<input type="text" value="room5"/>

Backup Mesh Config

- After finishing the mesh network configuration, refer to **Mesh>>Mesh Status** for viewing the result. A mesh root with 5 mesh nodes is online.

Mesh >> Mesh Status

Local Status [Refresh](#)

Device Name	VigorAP918R
MAC Address	00:50:7F:F1:7E:ED
Model	VigorAP918R
Operation Mode	MeshRoot
Link Status	Connected
Hop	0
Downlink Number	5
Downlink	00:1D:AA:04:F0:10 (VigorAP1000C) Wireless 5GHz (Ch36) (-38dBm)
	00:1D:AA:78:CF:B0 (VigorAP920R) Wireless 5GHz (Ch36) (-74dBm)
	00:1D:AA:68:D6:18 (VigorAP920RPD) Ethernet
	00:1D:AA:78:C9:20 (VigorAP920R) Wireless 5GHz (Ch36) (-54dBm)
	00:50:7F:F1:7E:EA (VigorAP918R) Wireless 5GHz (Ch36) (-33dBm)

Devices Total number of Clients: 0

Index	Status	Device Name	IP Address	MAC Address (Model)	Hop	Uplink	Uptime	Clients
1	Root	VigorAP918R	172.17.3.97	00:50:7F:F1:7E:ED (VigorAP918R)	0		0d 01:16:17	0
2	Online	room1	172.17.3.12	00:50:7F:F1:7E:EA (VigorAP918R)	1	00:50:7F:F1:7E:ED Wireless 5GHz (Ch36) (-30dBm)	0d 00:21:43	0
3	Online	room2	172.17.3.8	00:1D:AA:04:F0:10 (VigorAP1000C)	1	00:50:7F:F1:7E:ED Wireless 5GHz (Ch36) (-40dBm)	0d 00:44:50	0
4	Online	room3	172.17.3.6	00:1D:AA:78:C9:20 (VigorAP920R)	1	00:50:7F:F1:7E:ED Wireless 5GHz (Ch36) (-47dBm)	0d 01:01:46	0
5	Online	room4	172.17.3.98	00:1D:AA:78:CF:B0 (VigorAP920R)	1	00:50:7F:F1:7E:ED Wireless 5GHz (Ch36) (-64dBm)	0d 01:02:01	0
6	Online	room5	172.17.3.10	00:1D:AA:68:D6:18 (VigorAP920RPD)	0	00:50:7F:F1:7E:ED Ethernet	0d 01:03:05	0

● Online(sync ready) ● Online ● Offline Last updated: Thu Nov 8 18:40:51 2018

II-4-2 Mesh Status

This page shows that one Mesh Group can contain up to 8 devices. In the following figure, the 7th Device with hop 0 is one special Ethernet Backhaul. It means this node will use Ethernet cable to join the mesh group while others use the wireless link.

Mesh >> Mesh Status

Local Status		Refresh	
Device Name	VigorAP918R		
MAC Address	00:1D:AA:3F:B2:30		
Model	VigorAP918R		
Operation Mode	MeshRoot		
Group Name	VigorMesh		
Link Status	Connected		
Hop	0		
Downlink Number	0		

Devices						Total number of Clients: 0
Index	Status	Device Name	IP Address	MAC Address (Model)	Hop Uplink	Uptime Clients Speed Test
1	● Root	VigorAP918...	192.168.1.14	00:1D:AA:3F:B2:30 (VigorAP918R)	0	0d 03:53:41 0

● Online(sync ready) ● Online ● Offline
Last updated: Wed Jan 22 14:58:29 2020

Item	Description																																																																																																																																																																																
Local Status	Display general information for such VigorAP.																																																																																																																																																																																
Devices	<p>Display detailed information for this VigorAP (as mesh root) and mesh node(s) in the group.</p> <p>Index – Display the number of the device within a mesh group.</p> <p>Status – Display the role of the device within a mesh group.</p> <p>Device Name – Display the name of the device (for identification).</p> <p>IP Address – Display the IP address of the device.</p> <p>MAC Address – Display the MAC address of the device.</p> <p>Hop – Display the level of the devices within a mesh group. "0" means the access point is connected to a device by using Ethernet cable (wired). "1" to "3" means the level of the access point within a mesh group and it connects to other access point via wireless link.</p> <p>Uplink – Display the MAC address of the device that the AP connects to.</p>																																																																																																																																																																																
Total number of Clients	<p>Display the station list of all mesh devices.</p> <table border="1"> <thead> <tr> <th colspan="8">Station List of All Devices</th> </tr> <tr> <th>Index</th> <th>MAC Address</th> <th>Hostname</th> <th>Vendor</th> <th>SSID</th> <th>Channel</th> <th>RSSI</th> <th>TxRate(Kbps) RxRate(Kbps)</th> </tr> </thead> <tbody> <tr><td>1</td><td>00:50:7F:F0:C9:72</td><td>TA001029</td><td>DrayTek</td><td>staffs_4F</td><td>6</td><td>68%(-63dBm)</td><td>0 0</td></tr> <tr><td>2</td><td>00:50:7F:F0:D1:1D</td><td>ta002171</td><td>DrayTek</td><td>staffs_4F</td><td>6</td><td>41%(-73dBm)</td><td>0 0</td></tr> <tr><td>3</td><td>5C:97:F3:D3:D5:F7</td><td>Tze-Pingde...</td><td>Apple</td><td>staffs_4F</td><td>6</td><td>100%(-49dBm)</td><td>0 0</td></tr> <tr><td>4</td><td>40:98:AD:5B:F2:52</td><td>Tyronetkii...</td><td>Apple</td><td>staffs</td><td>6</td><td>55%(-68dBm)</td><td>0 0</td></tr> <tr><td>5</td><td>00:50:7F:37:6D:E5</td><td>N/A</td><td>DrayTek</td><td>staffs_4F</td><td>6</td><td>52%(-69dBm)</td><td>0 0</td></tr> <tr><td>6</td><td>00:50:7F:37:67:BE</td><td>N/A</td><td>DrayTek</td><td>staffs_4F</td><td>6</td><td>55%(-68dBm)</td><td>0 0</td></tr> <tr><td>7</td><td>30:F7:C5:1D:3D:11</td><td>N/A</td><td>Apple</td><td>guests</td><td>6</td><td>83%(-57dBm)</td><td>30 12</td></tr> <tr><td>8</td><td>40:F0:2F:22:EB:A0</td><td>N/A</td><td>LiteonTe</td><td>staffs</td><td>6</td><td>34%(-76dBm)</td><td>22 4</td></tr> <tr><td>9</td><td>18:65:90:DE:D4:E5</td><td>N/A</td><td>Apple</td><td>staffs_4F</td><td>6</td><td>100%(-44dBm)</td><td>0 0</td></tr> <tr><td>10</td><td>60:45:CB:57:1F:36</td><td>N/A</td><td>N/A</td><td>staffs_4F</td><td>6</td><td>15%(-84dBm)</td><td>0 0</td></tr> <tr><td>11</td><td>AC:5F:3E:62:E6:0D</td><td>N/A</td><td>Samsung</td><td>staffs_4F</td><td>6</td><td>81%(-58dBm)</td><td>0 0</td></tr> <tr><td>12</td><td>50:BC:96:E0:00:11</td><td>N/A</td><td>Apple</td><td>staffs</td><td>6</td><td>71%(-62dBm)</td><td>0 0</td></tr> <tr><td>13</td><td>04:B1:67:52:48:90</td><td>Redmi5-mys...</td><td>N/A</td><td>staffs_4F</td><td>6</td><td>45%(-72dBm)</td><td>0 0</td></tr> <tr><td>14</td><td>04:C2:3E:3F:CB:F8</td><td>android-ac...</td><td>HTC</td><td>staffs_4F</td><td>6</td><td>55%(-68dBm)</td><td>0 0</td></tr> <tr><td>15</td><td>0C:8B:FD:31:0B:78</td><td>N/A</td><td>Intel</td><td>staffs_4F</td><td>6</td><td>89%(-55dBm)</td><td>2 2</td></tr> <tr><td>16</td><td>58:48:22:EB:F8:62</td><td>android-5f...</td><td>Sony</td><td>staffs</td><td>6</td><td>55%(-68dBm)</td><td>0 0</td></tr> <tr><td>17</td><td>CC:9F:7A:63:11:27</td><td>N/A</td><td>N/A</td><td>staffs_4F5...</td><td>36</td><td>52%(-69dBm)</td><td>0 0</td></tr> <tr><td>18</td><td>20:47:DA:58:17:79</td><td>RedmiNote5...</td><td>N/A</td><td>staffs_4F5...</td><td>36</td><td>50%(-70dBm)</td><td>0 0</td></tr> <tr><td>19</td><td>70:81:EB:65:80:E5</td><td>cheng</td><td>Apple</td><td>staffs_4F5...</td><td>36</td><td>87%(-56dBm)</td><td>0 0</td></tr> <tr><td>20</td><td>8C:85:90:64:FE:A4</td><td>N/A</td><td>Apple</td><td>staffs_4F5...</td><td>36</td><td>36%(-75dBm)</td><td>0 0</td></tr> </tbody> </table>	Station List of All Devices								Index	MAC Address	Hostname	Vendor	SSID	Channel	RSSI	TxRate(Kbps) RxRate(Kbps)	1	00:50:7F:F0:C9:72	TA001029	DrayTek	staffs_4F	6	68%(-63dBm)	0 0	2	00:50:7F:F0:D1:1D	ta002171	DrayTek	staffs_4F	6	41%(-73dBm)	0 0	3	5C:97:F3:D3:D5:F7	Tze-Pingde...	Apple	staffs_4F	6	100%(-49dBm)	0 0	4	40:98:AD:5B:F2:52	Tyronetkii...	Apple	staffs	6	55%(-68dBm)	0 0	5	00:50:7F:37:6D:E5	N/A	DrayTek	staffs_4F	6	52%(-69dBm)	0 0	6	00:50:7F:37:67:BE	N/A	DrayTek	staffs_4F	6	55%(-68dBm)	0 0	7	30:F7:C5:1D:3D:11	N/A	Apple	guests	6	83%(-57dBm)	30 12	8	40:F0:2F:22:EB:A0	N/A	LiteonTe	staffs	6	34%(-76dBm)	22 4	9	18:65:90:DE:D4:E5	N/A	Apple	staffs_4F	6	100%(-44dBm)	0 0	10	60:45:CB:57:1F:36	N/A	N/A	staffs_4F	6	15%(-84dBm)	0 0	11	AC:5F:3E:62:E6:0D	N/A	Samsung	staffs_4F	6	81%(-58dBm)	0 0	12	50:BC:96:E0:00:11	N/A	Apple	staffs	6	71%(-62dBm)	0 0	13	04:B1:67:52:48:90	Redmi5-mys...	N/A	staffs_4F	6	45%(-72dBm)	0 0	14	04:C2:3E:3F:CB:F8	android-ac...	HTC	staffs_4F	6	55%(-68dBm)	0 0	15	0C:8B:FD:31:0B:78	N/A	Intel	staffs_4F	6	89%(-55dBm)	2 2	16	58:48:22:EB:F8:62	android-5f...	Sony	staffs	6	55%(-68dBm)	0 0	17	CC:9F:7A:63:11:27	N/A	N/A	staffs_4F5...	36	52%(-69dBm)	0 0	18	20:47:DA:58:17:79	RedmiNote5...	N/A	staffs_4F5...	36	50%(-70dBm)	0 0	19	70:81:EB:65:80:E5	cheng	Apple	staffs_4F5...	36	87%(-56dBm)	0 0	20	8C:85:90:64:FE:A4	N/A	Apple	staffs_4F5...	36	36%(-75dBm)	0 0
Station List of All Devices																																																																																																																																																																																	
Index	MAC Address	Hostname	Vendor	SSID	Channel	RSSI	TxRate(Kbps) RxRate(Kbps)																																																																																																																																																																										
1	00:50:7F:F0:C9:72	TA001029	DrayTek	staffs_4F	6	68%(-63dBm)	0 0																																																																																																																																																																										
2	00:50:7F:F0:D1:1D	ta002171	DrayTek	staffs_4F	6	41%(-73dBm)	0 0																																																																																																																																																																										
3	5C:97:F3:D3:D5:F7	Tze-Pingde...	Apple	staffs_4F	6	100%(-49dBm)	0 0																																																																																																																																																																										
4	40:98:AD:5B:F2:52	Tyronetkii...	Apple	staffs	6	55%(-68dBm)	0 0																																																																																																																																																																										
5	00:50:7F:37:6D:E5	N/A	DrayTek	staffs_4F	6	52%(-69dBm)	0 0																																																																																																																																																																										
6	00:50:7F:37:67:BE	N/A	DrayTek	staffs_4F	6	55%(-68dBm)	0 0																																																																																																																																																																										
7	30:F7:C5:1D:3D:11	N/A	Apple	guests	6	83%(-57dBm)	30 12																																																																																																																																																																										
8	40:F0:2F:22:EB:A0	N/A	LiteonTe	staffs	6	34%(-76dBm)	22 4																																																																																																																																																																										
9	18:65:90:DE:D4:E5	N/A	Apple	staffs_4F	6	100%(-44dBm)	0 0																																																																																																																																																																										
10	60:45:CB:57:1F:36	N/A	N/A	staffs_4F	6	15%(-84dBm)	0 0																																																																																																																																																																										
11	AC:5F:3E:62:E6:0D	N/A	Samsung	staffs_4F	6	81%(-58dBm)	0 0																																																																																																																																																																										
12	50:BC:96:E0:00:11	N/A	Apple	staffs	6	71%(-62dBm)	0 0																																																																																																																																																																										
13	04:B1:67:52:48:90	Redmi5-mys...	N/A	staffs_4F	6	45%(-72dBm)	0 0																																																																																																																																																																										
14	04:C2:3E:3F:CB:F8	android-ac...	HTC	staffs_4F	6	55%(-68dBm)	0 0																																																																																																																																																																										
15	0C:8B:FD:31:0B:78	N/A	Intel	staffs_4F	6	89%(-55dBm)	2 2																																																																																																																																																																										
16	58:48:22:EB:F8:62	android-5f...	Sony	staffs	6	55%(-68dBm)	0 0																																																																																																																																																																										
17	CC:9F:7A:63:11:27	N/A	N/A	staffs_4F5...	36	52%(-69dBm)	0 0																																																																																																																																																																										
18	20:47:DA:58:17:79	RedmiNote5...	N/A	staffs_4F5...	36	50%(-70dBm)	0 0																																																																																																																																																																										
19	70:81:EB:65:80:E5	cheng	Apple	staffs_4F5...	36	87%(-56dBm)	0 0																																																																																																																																																																										
20	8C:85:90:64:FE:A4	N/A	Apple	staffs_4F5...	36	36%(-75dBm)	0 0																																																																																																																																																																										

II-4-3 Mesh Discovery

Before a Mesh Node is connected, it is unable to check the device status from Mesh Root. This page can help to discover all Mesh devices around and offer the Link Status and Operation Mode of each Mesh device.

Mesh >> Mesh Discovery

Device List

Index	MAC Address	Model	Operation Mode	Link Status
1	00:1D:AA:04:F0:DC	VigorAP1000C	MeshRoot	Connected
2	00:1D:AA:63:2C:10	VigorAP920RPD	MeshNode(Wireless)	Connected
3	00:1D:AA:3F:4F:B2	VigorAP912C	AP	
4	00:1D:AA:3F:75:82	VigorAP912C	RangeExtender	
5	00:50:7F:F1:92:16	VigorAP903	MeshNode(Wireless)	Connected
6	00:1D:AA:04:F0:6C	VigorAP1000C	MeshNode(Wireless)	Connected
7	00:1D:AA:57:5D:38	VigorAP1000C	MeshRoot	Connected
8	00:1D:AA:04:F0:80	VigorAP1000C	MeshRoot	Connected
9	00:1D:AA:E4:8E:80	VigorAP912C	AP	
10	00:1D:AA:63:2C:00	VigorAP920R	AP	

Scan

Note: During the scanning process (about 10 seconds), no station is allowed to connect with the AP and Mesh Network may disconnect.

For obtaining the list of devices around this VigorAP, click **Scan**. Later, surrounding VigorAP device(s) will be displayed on this page.

II-4-4 Basic Configuration Sync

If you add one Mesh Node in a mesh group, the Mesh Root will send the basic configuration to the device. This page could help you to change the Mesh Root settings and deliver the new configuration of the Mesh Root to all "connected" Mesh Nodes.

Mesh >> Basic Configuration Sync

Select All

System Maintenance

Index	Name	Value
1	ManagementServer.URL	
2	ManagementServer.Username	
3	ManagementServer.Password	*****
4	ManagementServer.ConnectionRequestUsername	vigor
5	ManagementServer.ConnectionRequestPassword	password
6	X_00507F_System.Management.SkipQuickStartWizard	Enable
7	X_00507F_System.TR069Setting.CPEEnable	0
8	X_00507F_System.AdminmodePassword.Admin	admin
9	X_00507F_System.SyslogMail.SysLogAccess.SysLogEnable	0
10	X_00507F_System.SyslogMail.SysLogAccess.LogServerIP	
11	X_00507F_System.SyslogMail.SysLogAccess.LogServerPort	514
12	X_00507F_System.SyslogMail.SysLogAccess.LogLevel	
13	X_00507F_System.SyslogMail.MailAlert.MailAlertEnable	0
14	X_00507F_System.SyslogMail.MailAlert.SMTPServer	
15	X_00507F_System.SyslogMail.MailAlert.MailTo	
16	X_00507F_System.SyslogMail.MailAlert.MailFrom	
17	X_00507F_System.SyslogMail.MailAlert.Username	
18	X_00507F_System.SyslogMail.MailAlert.Password	*****
19	X_00507F_System.SyslogMail.MailAlert.UseTLS	1
20	X_00507F_System.SyslogMail.MailAlert.AdminLoginAlertEn	1
21	X_00507F_System.SyslogMail.MailAlert.SMTPServerPort	
22	X_00507F_System.AdminmodePassword.Password	*****

Wireless LAN (2.4GHz)

Index	Name	Value
1	X_00507F_WirelessLAN_AP.General.EnableWLAN	1
2	X_00507F_WirelessLAN_AP.General.SSID.1.ESSID	DrayTek-3FB230
3	X_00507F_WirelessLAN_AP.General.SSID.1.Enable	1
4	X_00507F_WirelessLAN_AP.General.SSID.1.Hide	0
5	X_00507F_WirelessLAN_AP.General.SSID.1.IsolateLAN	0
6	X_00507F_WirelessLAN_AP.General.SSID.1.IsolateMember	0

Available settings are explained as follows:

Item	Description
System Maintenance / Wireless LAN (2.4Hz) / Wireless LAN (5GHz)	Check the item(s) you want to make configuration sync. Apply - Click it to apply the settings configured by such AP to all connected mesh node. Note that this button is available only when such AP is in mesh root mode.

Tips for Mesh Network Setup

- Set up TWO mesh devices with uplink RSSI larger than -65dBm.
- Upgrade the firmware version of Mesh devices through Mesh link, starting from the mesh device with less hop number. For example, upgrade the firmware from the root, hop1 Mesh Node then hop2 Mesh Node, and so on.
- VigorMesh network supports up to 3 hops of mesh devices. However, it is suggested to connect the mesh group with less than or equals to 2 hops.

For your reference, we make a real mesh environment test and get the following record. (Use VigorAP APP to do internet speed test with different hops mesh node.)

Internet Download Speed (for root and hop1 ~ hop3):

iPad connects to Root : 80Mbps

iPad connects to hop1 Node : 49Mbps (Uplink RSSI : -55dBm)

iPad connects to hop2 Node : 41Mbps (Uplink RSSI : hop2 -64dBm / hop1 -55dBm)

iPad connects to hop3 Node : 26Mbps (Uplink RSSI : hop3 -62dBm / hop2 -68dBm / hop1 -55dBm)

- It is not suggested to use a wireless Mesh Node with Ethernet cable connected to a Mesh Root.
- If resetting a Mesh Root,
 - All "connected" Mesh Nodes will be informed to reset.
 - Group List and Group Key will be reset, too.
 - For those Mesh Nodes unable to reset, reset them manually. Reset the Group List by web or factory default.
- If resetting a Mesh Node,
 - Group List and Group Key will be cleared.
 - Link Status will become "New".
- Mesh network status also can be viewed and checked through the dashboard by clicking MESH NETWORK.

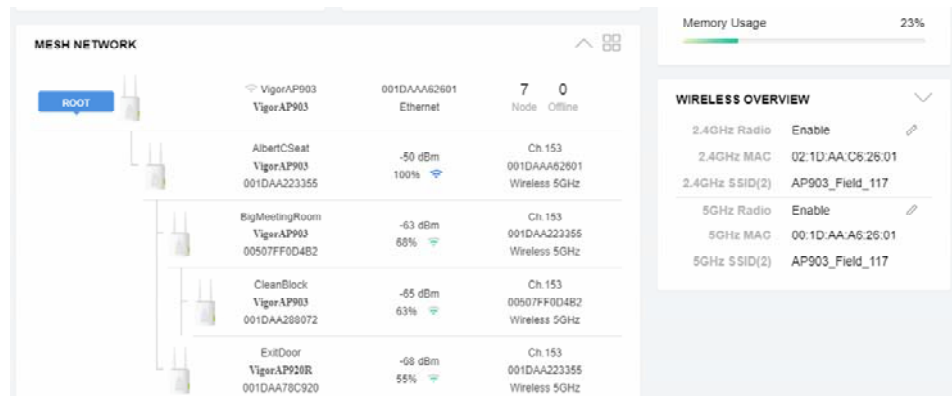

- If Mesh Search / Apply / Discover is worked too fast or is done with empty result, your request may be rejected. Please try again.
- Troubleshooting:
 - Check the firmware version. Please make sure all APs within the mesh group are in the newest firmware version.
 - Check the OP (operation) Mode. Make sure new Mesh Node doesn't accidentally get DHCP IP and becomes AP mode.
 - Check the country code and channels. For example, it is impossible for connecting a VigorAP 918R Mesh Root with 5G channel 36 to VigorAP920R Wireless Mesh Node in EU country code.
 - Check the channel load. Make sure it is not over 70%.

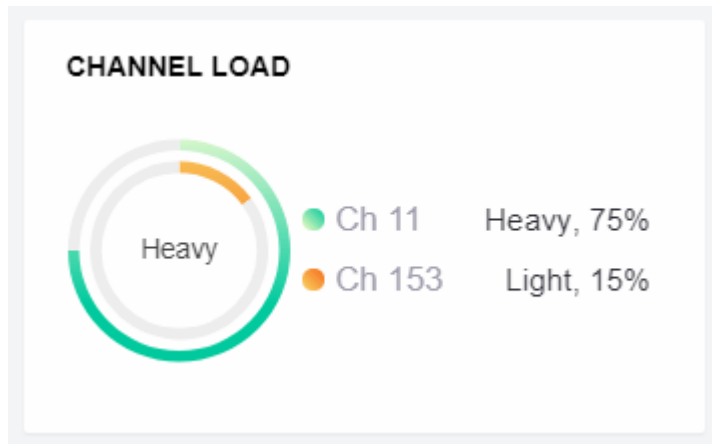

- Collect some Mesh logs and send the result to DrayTek for analyzing.

The screenshot shows the DrayTek Syslog Utility interface. The 'Log 過濾篩' (Log Filter) section has '關鍵字:' (Keywords) set to 'All' and '表用至:' (Apply to) set to 'All'. The 'APP' tab is selected, and the 'Mesh' sub-tab is active. The main log area displays a table of system logs.

系統時間	路由器時間	主機	訊息
2018-11-08 19:01:16	Nov 8 10:58:05	syslog	[dnn] dnn_pkt_recv Announce-Keepalive
2018-11-08 19:01:15	Nov 8 10:58:04	syslog	[dnn] dnn_pkt_send Alive
2018-11-08 19:01:04	Nov 8 10:57:52	syslog	[dnn] dnn_pkt_send Alive
2018-11-08 19:01:01	Nov 8 10:57:50	syslog	[dnn] dnn_pkt_recv Announce-Keepalive
2018-11-08 19:00:59	Nov 8 10:57:48	kernel	[7525.323564] [dnn] Mesh IE Record (Isolate) 00:1D-AA:5C:A6:C8
2018-11-08 19:00:53	Nov 8 10:57:41	syslog	[dnn] dnn_pkt_send Alive
2018-11-08 19:00:47	Nov 8 10:57:36	syslog	[dnn] dnn_pkt_recv Announce-Keepalive
2018-11-08 19:00:41	Nov 8 10:57:30	syslog	[dnn] dnn_pkt_send Alive
2018-11-08 19:00:39	Nov 8 10:57:28	kernel	[7505.200014] [dnn] Mesh IE Record (Isolate) 00:1D-AA:5C:A6:C8
2018-11-08 19:00:33	Nov 8 10:57:22	syslog	[dnn] dnn_pkt_recv Announce-Keepalive
2018-11-08 19:00:30	Nov 8 10:57:19	syslog	[dnn] dnn_pkt_send Alive
2018-11-08 19:00:19	Nov 8 10:57:08	syslog	[dnn] dnn_pkt_send Alive
2018-11-08 19:00:18	Nov 8 10:57:07	syslog	[dnn] dnn_pkt_recv Announce-Keepalive
2018-11-08 19:00:07	Nov 8 10:56:56	syslog	[dnn] dnn_pkt_send Alive

II-4-5 Advanced Config Sync

If you add one Mesh Node in a mesh group, the Mesh Root will synchronize the advanced configuration to the device based on the setting results on this page.

Mesh >> Advanced Configuration Sync

Select All

Bridge VLAN to Mesh

Index	Name	Value
1	X_00507F_LAN.GeneralSetup.BridgeVLANtoWDS	Enable

Roaming

Index	Name	Value
1	X_00507F_WirelessLAN_AP.Roaming.APAClientRoaming.EnMinBasicRate	0
2	X_00507F_WirelessLAN_AP.Roaming.APAClientRoaming.MinBasicRate	1Mbps
3	X_00507F_WirelessLAN_AP.Roaming.APAClientRoaming.RSSI	Disable_RSSI_Requirement
4	X_00507F_WirelessLAN_AP.Roaming.APAClientRoaming.StrictlyRSSISignal	73
5	X_00507F_WirelessLAN_AP.Roaming.APAClientRoaming.MinRSSISignal	66
6	X_00507F_WirelessLAN_AP.Roaming.APAClientRoaming.AdjacentRSSISignal	5
7	X_00507F_WirelessLAN_AP.Roaming.FastRoaming.Enable	0
8	X_00507F_WirelessLAN_AP.Roaming.FastRoaming.CachePeriod	10
9	X_00507F_WirelessLAN_AP.Roaming.FastTransitionRoaming.Enable	0
10	X_00507F_WirelessLAN_AP.Roaming.FastTransitionRoaming.DsOrAir	1
11	X_00507F_WirelessLAN_5G_AP.Roaming.APAClientRoaming.EnMinBasicRate	0
12	X_00507F_WirelessLAN_5G_AP.Roaming.APAClientRoaming.MinBasicRate	6Mbps
13	X_00507F_WirelessLAN_5G_AP.Roaming.APAClientRoaming.RSSI	Disable_RSSI_Requirement
14	X_00507F_WirelessLAN_5G_AP.Roaming.APAClientRoaming.StrictlyRSSISignal	73
15	X_00507F_WirelessLAN_5G_AP.Roaming.APAClientRoaming.MinRSSISignal	66
16	X_00507F_WirelessLAN_5G_AP.Roaming.APAClientRoaming.AdjacentRSSISignal	5
17	X_00507F_WirelessLAN_5G_AP.Roaming.FastRoaming.Enable	0
18	X_00507F_WirelessLAN_5G_AP.Roaming.FastRoaming.CachePeriod	10

Available settings are explained as follows:

Item	Description
Select All	All item(s) will be selected for making configuration sync.
Bridge VLAN to Mesh	Check to transmit the packets with VLAN tag to mesh nodes.

II-5 Universal Repeater Settings for Range Extender Mode

When you choose **Range Extender** as the operation mode, the Wireless LAN menu items (for 2.4GHz and 5GHz) will include General Setup, Security, Access Control, WPS, Advanced Setting, AP Discovery, WDS AP Status, Universal Repeater, Bandwidth Management, Airtime Fairness, Station Control, Roaming, Band Steering and Station List.

This section will introduce settings for Universal Repeater only.

For other wireless setting items (e.g., General Setup, Security, WPS, and etc.), please refer to II-3.

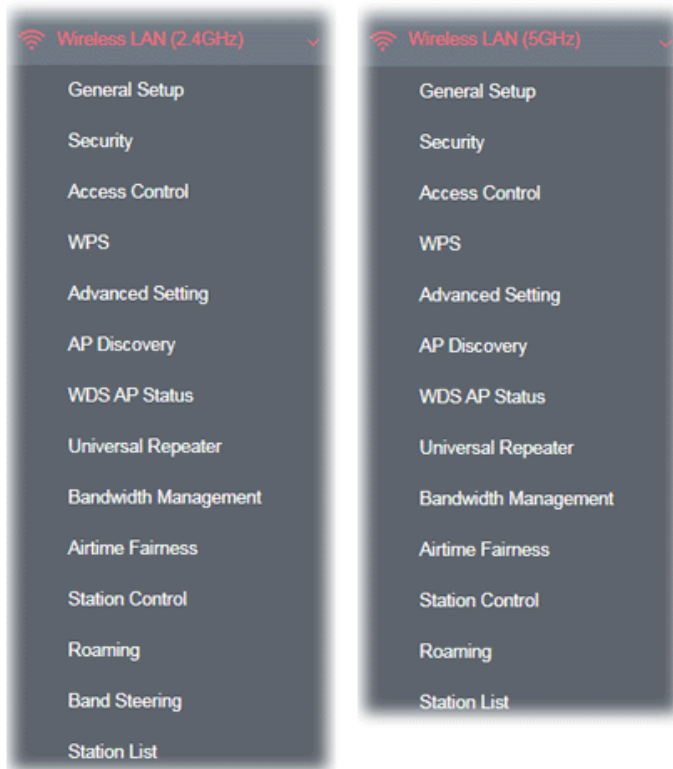

The following figure shows how VigorAP runs as Range Extender:



The access point can act as a wireless repeater; it can be Station and AP at the same time. It can use Station function to connect to a root AP and use AP function to serve all wireless stations within its coverage.

i Note:

While using **Universal Repeater** mode, the access point will demodulate the received signal. Please check if this signal is noise for the operating network, then have the signal modulated and amplified again. The output power of this mode is the same as that of AP mode.

Wireless LAN (2.4GHz) >> Universal Repeater

Universal Repeater Parameters

SSID	<input type="text"/>
MAC Address (Optional)	<input type="text"/>
Channel	2462MHz (Channel 11) ▾
Security Mode	WPA2/PSK ▾
Encryption Type	AES ▾
Pass Phrase	<input type="text"/>
Range Extender Band	None

Note: If Channel is modified, the Channel setting of AP would also be changed.

Universal Repeater IP Configuration

Connection Type	DHCP ▾
Device Name	AP918R

OK Cancel

Available settings are explained as follows:

Item	Description
Universal Repeater Parameters	
SSID	Display the SSID defined for Range Extender operation mode in Quick Start Wizard. Change the name of SSID whenever you want.
MAC Address (Optional)	Type the MAC address of access point that VigorAP 918R wants to connect to.
Channel	Means the channel of frequency of the wireless LAN. You may switch channel if the selected channel is under serious interference. If you have no idea of choosing the frequency, please select AutoSelect to let system determine for you.
Security Mode	There are several modes provided for you to choose. Each mode will bring up different parameters (e.g., WEP keys, Pass Phrase) for you to configure.

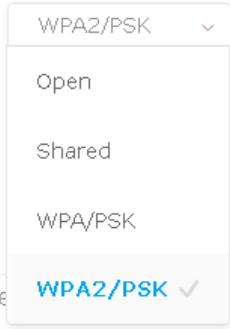
	
Encryption Type for Open/Shared	<p>This option is available when Open/Shared is selected as Security Mode.</p> <p>Choose None to disable the WEP Encryption. Data sent to the AP will not be encrypted. To enable WEP encryption for data transmission, please choose WEP.</p> <p>WEP Keys - Four keys can be entered here, but only one key can be selected at a time. The format of WEP Key is restricted to 5 ASCII characters or 10 hexadecimal values in 64-bit encryption level, or restricted to 13 ASCII characters or 26 hexadecimal values in 128-bit encryption level. The allowed content is the ASCII characters from 33(!) to 126(~) except '#' and ','.</p>
Encryption Type for WPA/PSK and WPA2/PSK	<p>This option is available when WPA/PSK or WPA2/PSK is selected as Security Mode.</p> <p>Select TKIP or AES as the algorithm for WPA.</p>
Pass Phrase	<p>Type 8~63 ASCII characters, such as 012345678 (or 64 Hexadecimal digits leading by 0x, such as "0x321253abcde...").</p>
Range Extender Band	<p>Display which wireless band (2.4G/5G) is currently used for Universal Repeater.</p> <p>None - No network connection.</p>
Enable AP Function	<p>If disabled, other stations cannot connect to this VigorAP even using the correct SSID.</p> <p>Thus, VigorAP can be used as range extender but not as an access point.</p> <p>In default, it is enabled.</p>
Universal Repeater IP Configuration	
Connection Type	<p>Choose DHCP or Static IP as the connection mode.</p> <p>DHCP - The wireless station will be assigned with an IP from VigorAP.</p> <p>Static IP - The wireless station shall specify a static IP for connecting to Internet via VigorAP.</p>
Device Name	<p>This setting is available when DHCP is selected as Connection Type.</p> <p>Type a name for the VigorAP as identification. Simply use the default name.</p>
IP Address	<p>This setting is available when Static IP is selected as Connection Type.</p> <p>Type an IP address with the same network segment of the LAN IP setting of VigorAP. Such IP shall be different with any IP address in LAN.</p>

Subnet Mask	This setting is available when Static IP is selected as Connection Type . Type the subnet mask setting which shall be the same as the one configured in LAN for VigorAP.
Default Gateway	This setting is available when Static IP is selected as Connection Type . Type the gateway setting which shall be the same as the default gateway configured in LAN for VigorAP.

After finishing this web page configuration, please click **OK** to save the settings.

II-6 LAN

Local Area Network (LAN) is a group of subnets regulated and ruled by modem.



II-6-1 General Setup

Click **LAN** to open the LAN settings page and choose **General Setup**.

Note:

Such page will be changed according to the Operation Mode selected. The following screen is obtained by choosing AP as the operation mode.

LAN >> General Setup

Ethernet TCP / IP and DHCP Setup

LAN IP Network Configuration <input checked="" type="checkbox"/> Enable DHCP Client IP Address: 192.168.1.14 Subnet Mask: 255.255.255.0 <input type="checkbox"/> Enable Management VLAN VLAN ID: 0	DHCP Server Configuration <input type="radio"/> Enable Server <input checked="" type="radio"/> Disable Server <input type="radio"/> Relay Agent WLAN Trusted DHCP Server: Server IP Address
DNS Server IP Address Primary IP Address: <input type="text"/> Secondary IP Address: <input type="text"/>	

OK Cancel

Available settings are explained as follows:

Item	Description
LAN IP Network Configuration	Enable DHCP Client - When it is enabled, VigorAP 918R will be treated as a client and can be managed / controlled by AP Management server offered by Vigor router (e.g., Vigor2860).

	<p>IP Address – Type in private IP address for connecting to a local private network (Default: 192.168.1.2).</p> <p>Subnet Mask – Type in an address code that determines the size of the network. (Default: 255.255.255.0/ 24)</p> <p>Enable Management VLAN – VigorAP 918R supports tag-based VLAN for wireless clients accessing Vigor device. Only the clients with the specified VLAN ID can access into VigorAP 918R.</p> <ul style="list-style-type: none"> ● VLAN ID – Type the number as VLAN ID tagged on the transmitted packet. “0” means no VALN tag.
<p>DHCP Server Configuration</p>	<p>DHCP stands for Dynamic Host Configuration Protocol. DHCP server can automatically dispatch related IP settings to any local user configured as a DHCP client.</p> <p>Enable Server - Enable Server lets the modem assign IP address to every host in the LAN.</p> <ul style="list-style-type: none"> ● Start IP Address - Enter a value of the IP address pool for the DHCP server to start with when issuing IP addresses. If the 1st IP address of your modem is 192.168.1.2, the starting IP address must be 192.168.1.3 or greater, but smaller than 192.168.1.254. ● End IP Address - Enter a value of the IP address pool for the DHCP server to end with when issuing IP addresses. ● Subnet Mask - Type in an address code that determines the size of the network. (Default: 255.255.255.0/ 24) ● Default Gateway - Enter a value of the gateway IP address for the DHCP server. ● Lease Time - It allows you to set the leased time for the specified PC. ● Primary DNS Server - You must specify a DNS server IP address here because your ISP should provide you with usually more than one DNS Server. If your ISP does not provide it, the modem will automatically apply default DNS Server IP address: 194.109.6.66 to this field. ● Secondary DNS Server - You can specify secondary DNS server IP address here because your ISP often provides you more than one DNS Server. If your ISP does not provide it, the modem will automatically apply default secondary DNS Server IP address: 194.98.0.1 to this field. <p>Relay Agent - Specify which subnet that DHCP server is located the relay agent should redirect the DHCP request to.</p> <ul style="list-style-type: none"> ● DHCP Relay Agent - It is available when Enable Relay Agent is selected. Set the IP address of the DHCP server you are going to use so the Relay Agent can help to forward the DHCP request to the DHCP server. <p>Disable Server - Disable Server lets you manually or use other DHCP server to assign IP address to every host in the LAN.</p> <ul style="list-style-type: none"> ● WLAN Trusted DHCP Server –There is no right for such VigorAP to assign IP address for wireless LAN user. However, you can specify another valid DHCP server on other VigorAP to make the wireless LAN client obtaining the IP address from the designated DHCP server.

	<p>Specify a DHCP server in such field. All the IP addresses of the devices on LAN of VigorAP will be assigned via such specified server. It is used to avoid IP assignment interference due to multiple DHCP servers in one LAN.</p>
DNS Server IP Address	<p>Primary DNS Server - You must specify a DNS server IP address here because your ISP should provide you with usually more than one DNS Server. If your ISP does not provide it, the modem will automatically apply default DNS Server IP address: 194.109.6.66 to this field.</p> <p>Secondary DNS Server - You can specify secondary DNS server IP address here because your ISP often provides you more than one DNS Server. If your ISP does not provide it, the modem will automatically apply default secondary DNS Server IP address: 194.98.0.1 to this field.</p>

After finishing this web page configuration, please click **OK** to save the settings.

II-6-2 Web Portal

This page allows you to configure a profile with specified URL for accessing into or display a message when a wireless/LAN user connects to Internet through this router. No matter what the purpose of the wireless/LAN client is, he/she will be forced into the URL configured here while trying to access into the Internet or the desired web page through this router. That is, a company which wants to have an advertisement for its products to users can specify the URL in this page to reach its goal.

LAN >> Web Portal

Web Portal Profile:

Index	Enable	Comments	Login Mode	Applied Interface	
1	<input type="checkbox"/>		None		Preview
2	<input type="checkbox"/>		None		Preview
3	<input type="checkbox"/>		None		Preview
4	<input type="checkbox"/>		None		Preview

Note: The AP must connect to the Internet before webpage redirection will work.

OK

Cancel

Available settings are explained as follows:

Item	Description
Index	Display the number link which allows you to configure the profile.
Enable	Check the box to enable such profile.
Comments	Display the content (Disable, URL Redirect or Message) of the profile.
Login Mode	Display the login mode that a client uses to access into Internet.
Applied Interface	Display the applied interfaces of the profile.
Preview	Open a preview window according to the configured settings.

After finishing this web page configuration, please click **OK** to save the settings.

To configure the profile, click any index number link to open the following page.

LAN >> Web Portal

Web Portal

Enable

Comments
 Carrie_Floor

Welcome message
 Welcome!
 We are pleased to provide free Wi-Fi to you!

Default (Max 1024 characters)

Redirect Page
 None
 URL: _____

Authentication
 None
 Button Click

Applied Interfaces

LAN LAN (Works on universal repeater mode)

WLAN 2.4GHz SSID1 (DrayTek-3FB230)
 SSID2 (mk_carrie)
 SSID3
 SSID4

WLAN 5GHz SSID1 (DrayTek-3FB230)
 SSID2 (mk_carrie)
 SSID3
 SSID4

Note: The AP must connect to the Internet before webpage redirection will work.

Available settings are explained as follows:

Item	Description
Enable	Check the box to enable this function.
Comments	Enter a brief comment to explain such web portal profile.
Welcome message	Enter words or sentences here. The message will be displayed on the screen for several seconds when the wireless users access into the web page through the router. <ul style="list-style-type: none"> Default – Click it to restore the default content.
Redirect Page	None - User can access into Internet directly. URL - Any user who wants to access into Internet through this router will be redirected to the URL specified here first. It is a useful method for the purpose of advertisement. For example, force the wireless user(s) in hotel to access into the web page that the hotel wants the user(s) to visit.
Authentication	None – User can access into Internet directly without authentication. Button Click – When a client tries to access into Internet, a welcome message page with a button named “Accept” will appear on the screen first. The client must click that button (Accept) and then he/she is allowed to access Internet.
Applied Interfaces	Check the box(es) representing different interfaces to be applied by

such profile.

- **LAN** – If it is selected and Universal Repeater is specified as connection mode for such AP, both LAN client and WLAN client can access into Internet via web portal. Yet, if AP mode is selected, only wireless LAN client shall access into Internet via web portal.
 - **WLAN 2.4GHz/5GHz** - The advantage is that each SSID (1/2/3/4) for wireless network can be applied with different web portal separately.
-

After finishing this web page configuration, please click **OK** to save the settings.

Chapter III Management



III-1 System Maintenance

For the system setup, there are several items that you have to know the way of configuration: Status, TR-069, Administrator Password, Configuration Backup, Syslog/Mail Alert, Time and Date, SNMP, Management, Reboot System, and Firmware Upgrade.

Below shows the menu items for System Maintenance.

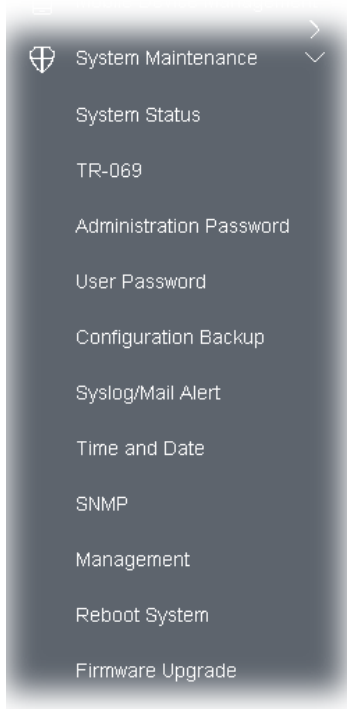

III-1-1 System Status

The **System Status** provides basic network settings of Vigor modem. It includes LAN and WAN interface information. Also, you could get the current running firmware version or firmware related information from this presentation.

System Status

```

Model                : VigorAP918R
Device Name          : VigorAP918R
Firmware Version     : 1.3.0
Build Date/Time      : r11019 Thu, 12 Sep 2019 20:21:16
System Uptime        : 0d 05:15:49
Operation Mode       : Range Extender
  
```

System	
Memory Total	: 236772 kB
Memory Left	: 95840 kB
Cached Memory	: 31940 kB / 236772 kB

LAN	
MAC Address	: 00:1D:AA:3F:B2:30
IP Address	: 192.168.1.14
IP Mask	: 255.255.255.0

Wireless LAN (2.4GHz)	
MAC Address	: 00:1D:AA:3F:B2:30
SSID	: DrayTek-3FB230
Channel	: 11
Driver Version	: 10.4

Wireless LAN (5GHz)	
MAC Address	: 00:1D:AA:3F:B2:31
SSID	: DrayTek-3FB230
Channel	: Auto(36)
Driver Version	: 10.4

WARNING: Your AP is still set to default password. You should change it via System Maintenance menu.

Each item is explained as follows:

Item	Description
Model /Device Name	Display the model name of the modem.
Firmware Version	Display the firmware version of the modem.
Build Date/Time	Display the date and time of the current firmware build.
System Uptime	Display the period that such device connects to Internet.
Operation Mode	Display the operation mode that the device used.
System	
Memory total	Display the total memory of your system.
Memory left	Display the remaining memory of your system.
LAN	
MAC Address	Display the MAC address of the LAN Interface.
IP Address	Display the IP address of the LAN interface.
IP Mask	Display the subnet mask address of the LAN interface.
Wireless LAN (2.4GHz/5GHz)	
MAC Address	Display the MAC address of the WAN Interface.
SSID	Display the SSID of the device.
Channel	Display the channel that the station used for connecting with such device.

III-1-2 TR-069

This device supports TR-069 standard. It is very convenient for an administrator to manage a TR-069 device (Vigor router, AP and etc.) through VigorACS (Auto Configuration Server).

System Maintenance >> TR069 Settings

ACS Settings

URL	<input type="text" value="http://192.168.105.141:8080/ACSserver/services,"/>	Wizard
Username	<input type="text" value="acs"/>	
Password	<input type="password" value="....."/>	
	TestWith Inform	Event Code PERIODIC
Last Inform Response Time : 		

CPE Settings

Enable	<input checked="" type="checkbox"/>
SSL(HTTPS) Mode	<input type="checkbox"/>
On	LAN-A
URL	<input type="text" value="http://192.168.1.2:8069/cwm/CRN.html"/>
Port	<input type="text" value="8069"/>
Username	<input type="text" value="vigor"/>
Password	<input type="password" value="....."/>

Note : SSL(HTTPS) Mode only works when Vigor ACS SI is 1.1.6 and above version.
Please set default gateway, no matter choose LAN-A or LAN-B.

Periodic Inform Settings

Enable	<input checked="" type="checkbox"/>
Interval Time	<input type="text" value="900"/> second(s)

STUN Settings

<input checked="" type="radio"/> Enable <input type="radio"/> Disable	
Server Address	<input type="text" value="192.168.105.141"/>
Server Port	<input type="text" value="8478"/>
Minimum Keep Alive Period	<input type="text" value="60"/> second(s)
Maximum Keep Alive Period	<input type="text" value="-1"/> second(s)

OK Cancel

Available settings are explained as follows:

Item	Description
ACS Settings	Wizard – Click it to enter the IP address of VigorACS server host, port number and the handler.

	<p>URL/Username/Password – Such data must be typed according to the ACS (Auto Configuration Server) you want to link. Please refer to Auto Configuration Server user’s manual for detailed information.</p> <p>Test With Inform – Click it to send a message based on the event code selection to test if such CPE is able to communicate with VigorACS SI server.</p> <p>Event Code – Use the drop down menu to specify an event to perform the test.</p> <p>Last Inform Response Time – Display the time that VigorACS server made a response while receiving Inform message from CPE last time.</p>
CPE Settings	<p>Such information is useful for Auto Configuration Server (ACS).</p> <p>Enable– Check the box to allow the CPE Client to connect with Auto Configuration Server.</p> <p>SSL(HTTPS) Mode - Check the box to allow the CPE client to connect with ACS through SSL.</p> <p>On – Choose the interface (LAN-A or LAN-B) for VigorAP 918R connecting to ACS server.</p> <p>Port – Sometimes, port conflict might be occurred. To solve such problem, you might change port number for CPE.</p> <p>Username/Password – Type the username and password that VigorACS can use to access into such CPE.</p>
Periodic Inform Settings	<p>The default setting is Enable. Please set interval time or schedule time for the AP to send notification to VigorACS server.</p> <p>Interval Time – Type the value for the interval time setting. The unit is “second”.</p>
STUN Settings	<p>The default is Disable.</p> <p>If you click Enable, please type the relational settings listed below:</p> <p>Server Address – Type the IP address of the STUN server.</p> <p>Server Port – Type the port number of the STUN server.</p> <p>Minimum Keep Alive Period – If STUN is enabled, the CPE must send binding request to the server for the purpose of maintaining the binding in the Gateway. Please type a number as the minimum period. The default setting is “60 seconds”.</p> <p>Maximum Keep Alive Period – If STUN is enabled, the CPE must send binding request to the server for the purpose of maintaining the binding in the Gateway. Please type a number as the maximum period. A value of “-1” indicates that no maximum period is specified.</p>

After finishing this web page configuration, please click **OK** to save the settings.

III-1-3 Administrator Password

This page allows you to set new password for accessing into web user interface of VigorAP.

System Maintenance >> Administration Password

Administrator Settings

Account	<input type="text" value="admin"/>
Old Password	<input type="text"/>
New Password	<input type="text"/>
Confirm Password	<input type="text"/>
Password Strength:	<input type="button" value="Weak"/> <input type="button" value="Medium"/> <input type="button" value="Strong"/>
Strong password requirements: 1. Have at least one upper-case letter and one lower-case letter. 2. Including non-alphanumeric characters is a plus.	
Note : Authorization Account can contain only a-z A-Z 0-9 , ~ ` ! @ \$ % ^ * () _ + = { } [] ; < > . ? Authorization Password can contain only a-z A-Z 0-9 , ~ ` ! @ # \$ % ^ & * () _ + = { } [] \ ; < > . ? /	
<input type="button" value="OK"/> <input type="button" value="Cancel"/>	

Available settings are explained as follows:

Item	Description
Account	Enter the name for accessing into web user Interface.
Old Password	Enter the old password for accessing into the web user interface.
New Password	Enter in new password in this filed.
Confirm Password	Enter the new password again for confirmation.
Password Strength	The system will display the password strength (represented with the word of weak, medium or strong) of the password specified above.

When you click **OK**, the login window will appear. Please use the new password to access into the web user interface again.

III-1-4 User Password

This page allows you to set new account and password for accessing the web pages under User Mode.

System Maintenance >> User Password

User Password

Enable User Mode

Account

Password

Confirm Password

Note: Authorization Account can contain only a-z A-Z 0-9 , ~ ` ! @ \$ % ^ * () _ + = { } [] | ; < > . ?
 Authorization Password can contain only a-z A-Z 0-9 , ~ ` ! @ # \$ % ^ & * () _ + = { } [] \ ;
 < > . ? /

Available settings are explained as follows:

Item	Description
Enable User Mode	After checking this box, you can access into the web user interface with the password typed here for simple web configuration. The settings on simple web user interface will be different with full web user interface accessed by using the administrator password.
Account	Enter a user name.
Password	Enter in new password in this field. The length of the password is limited to 31 characters.
Confirm Password	Enter the new password again.

Click **OK** to save the settings.

Settings to be configured in User Mode will be less than settings in Admin Mode. Only basic configuration settings will be available in User Mode.

III-1-5 Configuration Backup

Such function can be used to backup/restore the VigorAP 918R settings.

System Maintenance >> Configuration Backup

Configuration Backup / Restoration

Restoration

Select a configuration file.

Please enter the password and click Restore to upload the configuration file.

Password (optional):

Note: 1. You will need the same password to do configuration restoration.
2. The configuration file from the supported model list would be adopted.

Backup

Please specify a password and click Backup to download current configuration as an encrypted file.

Protect with password

Password (Max. 23 characters allowed)

Confirm Password

Available settings are explained as follows:

Item	Description
Restoration	Upload - Click it to specify a file to be restored. Password (optional) - Enter a password for configuration restoration. Restore - Click it to restore the configuration file to VigorAP.
Backup	Perform the configuration backup of this device. Protect with password - For the sake of security, the configuration file for the access point can be encrypted. Password - Type several characters as the password for encrypting the configuration file. Confirm Password - Type the password again for confirmation. Backup - Click it to backup the configuration file.

Follow the steps below to backup your configuration.

1. Go to **System Maintenance >> Configuration Backup**.
2. If required, check the box of Protect with password and enter the password.
3. Click **Backup** to get into the following dialog. The configuration will download automatically to your computer as a file named **config.cfg**.

i Note:

Backup for Certification must be done independently. The Configuration Backup does not include information of Certificate.

Follow the steps below to restore your configuration.

1. Go to **System Maintenance >> Configuration Backup**.
2. Click **Upload** to choose the correct configuration file for uploading to the AP.
3. Click **Restore** and wait for few seconds.

III-1-6 Syslog/Mail Alert

SysLog function is provided for users to monitor AP. There is no bother to directly get into the Web user interface of the AP or borrow debug equipments.

System Maintenance >> Syslog / Mail Alert Setup

Syslog Access Setup

Enable	<input type="checkbox"/>
Server IP Address	<input type="text"/>
Destination Port	<input type="text" value="514"/>
Log Level	<input type="text" value="All"/>

Mail Alert Setup

Enable	<input type="checkbox"/>
SMTP Server	<input type="text"/>
Mail To	<input type="text"/>
Mail From	<input type="text"/>
User Name	<input type="text"/>
Password	<input type="text"/>
Use TLS	<input checked="" type="checkbox"/>
Enable E-Mail Alert:	
<input checked="" type="checkbox"/> When Admin Login AP	

Available settings are explained as follows:

Item	Description
Syslog Access Setup	<p>Enable - Check Enable to activate function of Syslog.</p> <p>Server IP Address -The IP address of the Syslog server.</p> <p>Destination Port -Assign a port for the Syslog protocol. The default setting is 514.</p> <p>Log Level - Specify which level of the severity of the event will be recorded by Syslog.</p>
Mail Alert Setup	<p>Enable - Check Enable to activate function of mail alert.</p> <p>SMTP Server - The IP address of the SMTP server.</p> <p>Mail To - Assign a mail address for sending mails out.</p> <p>Mail From - Assign a path for receiving the mail from outside.</p> <p>User Name - Type the user name for authentication.</p> <p>Password - Type the password for authentication.</p> <p>Use TLS - Check this box to encrypt alert mail. However, if the SMTP</p>

server specified here does not support TLS protocol, the alert mail with encrypted data will not be received by the receiver.

Enable E-Mail Alert - VigorAP will send an e-mail out when a user accesses into the user interface by using web or telnet.

When Admin Login AP - Enable/disable the function. When it is enabled, VigorAP will send out an e-mail to the recipient defined above when a user tries to access into VigorAP by entering login username and password.

Click **OK** to save the settings.

III-1-7 Time and Date

It allows you to specify where the time of VigorAP should be inquired from.

System Maintenance >> Time and Date

Time Information

Current System Time
status

Time Setting

Enable NTP Client
Time Zone
NTP Server
Daylight Saving
NTP synchronization

OK

Cancel

Available parameters are explained as follows:

Item	Description
Current System Time	Click Inquire Time to get the current time.
Enable NTP Client	Select to inquire time information from Time Server on the Internet using assigned protocol.
Time Zone	Select a time protocol.
NTP Server	Type the IP address of the time server. Use Default - Click it to choose the default NTP server.
Daylight Saving	Check the box to enable the daylight saving. Such feature is available for certain area.
NTP synchronization	Select a time interval for updating from the NTP server.

Click **OK** to save these settings.

III-1-8 SNMP

This page allows you to configure settings for SNMP and SNMPV3 services.

The SNMPv3 is **more secure than** SNMP through the authentication method (support e.g., MD5) for the management needs.

System Maintenance >> SNMP

SNMP Agent

<input checked="" type="checkbox"/>	Enable SNMP Agent
<input checked="" type="checkbox"/>	Enable SNMPV3 Agent
USM User	<input type="text"/>
Auth Algorithm	<input type="text" value="No Auth"/>
Auth Password	<input type="password"/>

Note: SNMP V1/V2c is read-only and SNMP V3 is read-write.

Available settings are explained as follows:

Item	Description
Enable SNMP Agent	Check it to enable this function.
Enable SNMPV3 Agent	Check it to enable this function.
USM User	USM means user-based security mode. Type a username which will be used for authentication. The maximum length of the text is limited to 23 characters.
Auth Algorithm	Choose one of the encryption methods listed below as the authentication algorithm.
Auth Password	Type a password for authentication. The maximum length of the text is limited to 23 characters.

Click **OK** to save these settings.

III-1-9 Management

This page allows you to specify the port number for HTTP and HTTPS server.

System Maintenance >> Management

Device Name

<p>Access Control</p> <p><input checked="" type="checkbox"/> Allow management from WLAN</p> <p><input checked="" type="checkbox"/> Enable Telnet Server</p> <hr/> <p>Access List</p> <p><input type="checkbox"/> Enable access list</p> <table border="0" style="width: 100%;"> <thead> <tr> <th style="text-align: left;">List</th> <th style="text-align: left;">IP</th> <th style="text-align: left;">Mask</th> </tr> </thead> <tbody> <tr> <td>1.</td> <td><input type="text"/></td> <td><input type="text" value="255.255.255.255 / 32"/> v</td> </tr> <tr> <td>2.</td> <td><input type="text"/></td> <td><input type="text" value="255.255.255.255 / 32"/> v</td> </tr> <tr> <td>3.</td> <td><input type="text"/></td> <td><input type="text" value="255.255.255.255 / 32"/> v</td> </tr> <tr> <td>4.</td> <td><input type="text"/></td> <td><input type="text" value="255.255.255.255 / 32"/> v</td> </tr> <tr> <td>5.</td> <td><input type="text"/></td> <td><input type="text" value="255.255.255.255 / 32"/> v</td> </tr> </tbody> </table>	List	IP	Mask	1.	<input type="text"/>	<input type="text" value="255.255.255.255 / 32"/> v	2.	<input type="text"/>	<input type="text" value="255.255.255.255 / 32"/> v	3.	<input type="text"/>	<input type="text" value="255.255.255.255 / 32"/> v	4.	<input type="text"/>	<input type="text" value="255.255.255.255 / 32"/> v	5.	<input type="text"/>	<input type="text" value="255.255.255.255 / 32"/> v	<p>Port Setup</p> <p>HTTP Port <input type="text" value="80"/> (Default:80)</p> <p>HTTPS Port <input type="text" value="443"/> (Default:443)</p> <hr/> <p>Panel Control</p> <p><input type="checkbox"/> Disable LED</p> <p><input type="checkbox"/> Enable Default Configuration Wizard</p>
List	IP	Mask																	
1.	<input type="text"/>	<input type="text" value="255.255.255.255 / 32"/> v																	
2.	<input type="text"/>	<input type="text" value="255.255.255.255 / 32"/> v																	
3.	<input type="text"/>	<input type="text" value="255.255.255.255 / 32"/> v																	
4.	<input type="text"/>	<input type="text" value="255.255.255.255 / 32"/> v																	
5.	<input type="text"/>	<input type="text" value="255.255.255.255 / 32"/> v																	

Available parameters are explained as follows:

Item	Description
Device Name	The default setting is VigorAP 918R. Change the name if required.
Access Control	<p>Allow management from WLAN - Enable the checkbox to allow system administrators to login from wireless LAN.</p> <p>Enable Telnet Server- The administrator / user can access into the command line interface of VigorAP remotely for configuring settings.</p>
Access List	Enable access list - Check the box to specify that the system administrator can only login from a specific host or network defined in the list. A maximum of five IPs/subnet masks is allowed.
Port Setup	HTTP port/HTTPS port -Specify user-defined port numbers for the HTTP and HTTPS servers.
Panel Control	<p>Disable LED - The LEDs blink always since VigorAP is powered on. Some people might not like that. Therefore the function of LED is allowed to be disabled to make people feeling comfortable and undisturbed. After checking it, all the LEDs on VigorAP will light off immediately after clicking OK.</p> <p>Enable Default Configuration Wizard - Default setting is enabled. When it is enabled, you will be guided into Quick Start Wizard</p>

whenever clicking the DrayTek logo on the top of the web user interface.

Such function will be disabled if you have configured Operation Mode, WLAN>>General Setup, WLAN>>Bandwidth Management, WLAN>>Station Control or System Maintenance>>Administration Password.

Click **OK** to save these settings.

III-1-10 Reboot System

The web user interface may be used to restart your modem. Click **Reboot System** from **System Maintenance** to open the following page.

System Maintenance >> Reboot System

Reboot System

Do You want to reboot your AP ?

Using current configuration

Using factory default configuration

OK

If you want to reboot the modem using the current configuration, check **Using current configuration** and click **OK**. To reset the modem settings to default values, check **Using factory default configuration** and click **OK**. The modem will take 5 seconds to reboot the system.

Note:

When the system pops up Reboot System web page after configuring the web settings, please click **OK** to reboot your device for ensuring normal operation and preventing unexpected errors of the modem in the future.

III-1-11 Firmware Upgrade

Before upgrading your modem firmware, you need to install the Modem Tools. The **Firmware Upgrade Utility** is included in the tools. The following web page will guide you to upgrade firmware by using an example. Note that this example is running over Windows OS (Operating System).

Download the newest firmware from DrayTek's web site or FTP site. The DrayTek web site is www.draytek.com (or local DrayTek's web site) and FTP site is [ftp.draytek.com](ftp://ftp.draytek.com).

Click **System Maintenance**>> **Firmware Upgrade** to launch the Firmware Upgrade Utility.

System Maintenance >> Firmware Upgrade

Firmware Update

Select a firmware file.

Click Upgrade to upload the file.

Firmware Version Status

[Refresh Latest Firmware](#)

Current Firmware Version	: 1.3.0
The Latest Firmware Version	: N/A

Click **Download** to locate the newest firmware from your hard disk and click **Upgrade**.

System Maintenance >> Firmware Upgrade

Firmware Update

Firmware Upgrade is in progress... It must NOT be interrupted!



Firmware Version Status

[Refresh Latest Firmware](#)

Current Firmware Version	: 1.3.3
The Latest Firmware Version	: N/A

III-2 Central AP Management

Such menu allows you to configure VigorAP device to be managed by Vigor router.

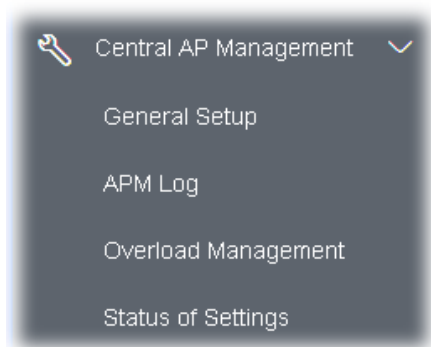

III-2-1 General Setup

Central AP Management >> General Setup

Vigor AP Management

- Enable AP Management
- Enable Auto Provision

OK

Cancel

Note: LAN-B cannot support APM feature.

Available settings are explained as follows:

Item	Description
Enable AP Management	Check the box to enable the function of AP Management (APM).
Enable Auto Provision	VigorAP 918R can be controlled under Central AP Management in Vigor router. When both Vigor router series and VigorAP 918R have such feature enabled, once VigorAP 918R is registered to Vigor router series, the WLAN profile pre-configured on Vigor router series will be applied to VigorAP 918R immediately. Thus, it is not necessary to configure VigorAP 918R separately.

Click **OK** to save these settings.

III-2-2 APM Log

This page will display log information related to wireless stations connected to VigorAP 918R and central AP management.

Such information also will be delivered to Vigor router (e.g., Vigor2862 or Vigor2926 series) and be shown on **Central AP Management>>Event Log** of Vigor router.

Central AP Management >> APM Log

APM Log Information

| [Clear](#) | [Refresh](#) | [Line wrap](#) |

```
Aug 24-13:02:54 syslog: [APM] Request done.
Aug 24-10:47:27 syslog: [APM] Get Traffic data.
Aug 24-10:47:27 syslog: [APM] Request done.
Aug 24-10:52:28 syslog: [APM] Get Traffic data.
Aug 24-10:52:28 syslog: [APM] Request done.
Aug 24-10:42:26 syslog: [APM] Get Traffic data.
Aug 24-10:42:26 syslog: [APM] Request done.
Aug 24-10:47:27 syslog: [APM] Get Traffic data.
Aug 24-10:47:27 syslog: [APM] Request done.
Aug 24-10:52:28 syslog: [APM] Get Traffic data.
Aug 24-10:52:28 syslog: [APM] Request done.
Aug 24-10:57:29 syslog: [APM] Get Traffic data.
Aug 24-10:57:29 syslog: [APM] Request done.
Aug 24-11:02:30 syslog: [APM] Get Traffic data.
Aug 24-11:02:30 syslog: [APM] Request done.
Aug 24-11:07:31 syslog: [APM] Get Traffic data.
```

III-2-3 Overload Management

Load Balance can help to distribute the traffic for all of the access points (e.g., VigorAP 918R) registered to Vigor router. Thus, the bandwidth will not be occupied by certain access points.

However, traffic overload might be occurred if too many wireless stations connected to VigorAP 918R for data incoming and outgoing. Therefore, "Force Overload Disassociation" is required to terminate the network connection of the client's station to release network traffic. When the function of "Force Overload Disassociation" in web user interface of Vigor router (e.g., Vigor2860 or Vigor2925 series) is enabled, wireless clients specified in **black list** of such web page will be disassociated to solve the problem of traffic overload.

The following web page is used to configure white list and black list for wireless stations.

Central AP Management >> Overload Management

Overload Management

MAC Address Filter of Force Overload Disassociation

Index	MAC Address	Comment
White List		
Black List		

Client's MAC Address : : : : : :

Apply to : White List ▾

Comment :

Note: When force overload disassociation is enabled, clients in black list will be disassociated first. Clients in white list will not be disassociated.

Available settings are explained as follows:

Item	Description
White List/Black List	<p>Display the information (such as index number, MAC address and comment) for all of the members in White List/Black List.</p> <p>Wireless stations listed in Black List will be forcefully disconnected first when traffic overload occurs and "Force Overload Disassociation" is enabled.</p>
Client's MAC Address	Specify the MAC Address of the remote/local client.
Apply to	<p>White List - MAC address listed inside Client's MAC Address will be categorized as one of members in White List.</p> <p>Black List - MAC address listed inside Client's MAC Address will be categorized as one of members in Black List.</p>

Comment	Type a brief description for the specified client's MAC address.
Add	Add a new MAC address into the White List/Black List.
Delete	Delete the selected MAC address in the White List/Black List.
Edit	Edit the selected MAC address in the White List/Black List.
Cancel	Give up the configuration.

Click **OK** to save these settings.

III-2-4 Status of Settings

Load Balance can help to distribute the traffic for all of the access points (e.g., VigorAP 918Rs) registered to Vigor 2862 or Vigor2926 series. This web page displays the settings related to Load Balance for VigorAP 918R. In which, By Station Number, By Traffic and Force Overload Disassociation indicate settings configured in Vigor 2862 or Vigor2926 series.

Central AP Management >> Status of Settings

Function Name	Status	Value
Load Balance		
Station Number Threshold	X	
Max WLAN(2.4GHz) Station Number		128
Max WLAN(5GHz) Station Number		128
Traffic Threshold	X	
Upload Limit		None bps
Download Limit		None bps
Force Overload Disassociation	X	
Disassociate By		None
RSSI Threshold		-50 dBm
Rogue AP Detection		
Rogue AP Detection	X	

"X" means the function is not enabled or VigorAP 918R has not registered to any Vigor router yet.

Below shows a setting example for Load Balance settings configured in Vigor 2862 or Vigor2926 series.

Central Management >> AP >> Load Balance

AP Load Balance By Station Number or Traffic

Station Number Threshold

Wireless LAN (2.4GHz) (3-128)

Wireless LAN (5GHz) (3-128)

Traffic Threshold

Upload Limit bps (Default unit: K)

Download Limit bps (Default unit: K)

Action When Threshold Exceeded

Stop accepting new connections

Dissociate existing station by longest idle time

Dissociate existing station by worst signal strength if it is less than - dBm (%)

III-3 Mobile Device Management

Such feature can control / manage the mobile devices accessing the wireless network of VigorAP. VigorAP offers wireless LAN service for mobile device(s), PC users, MAC users or other users according to the policy selected.

Below shows the menu items for Mobile Device Management (MDM).

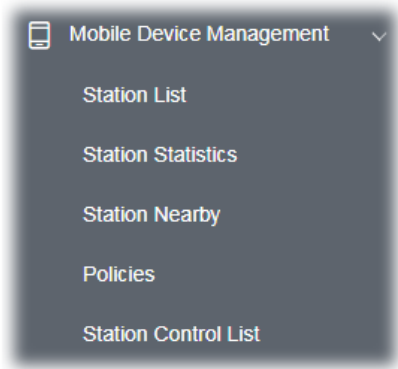

III-3-1 Station List

Station List provides the information related to the number of clients connecting to VigorAP, used bandwidth and the statistics of the AP device OS. Besides, users can create access control policies, device objects and set black & white list for

III-3-1-1 Connected Number

This page lists the graph for the number of wireless stations connected to this Access Point with different time phases.

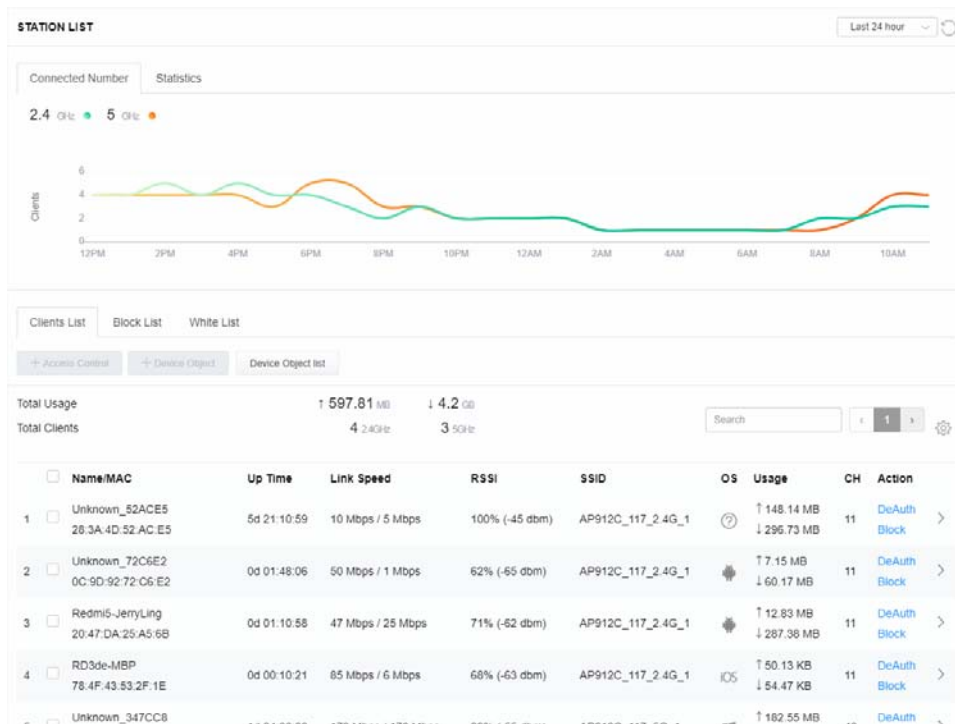

III-3-1-2 Statistics

The number of detected devices and the number of device(s) passed/blocked according to the policy specified in **Mobile Device Management>>Policy** can be illustrated as doughnut chart.

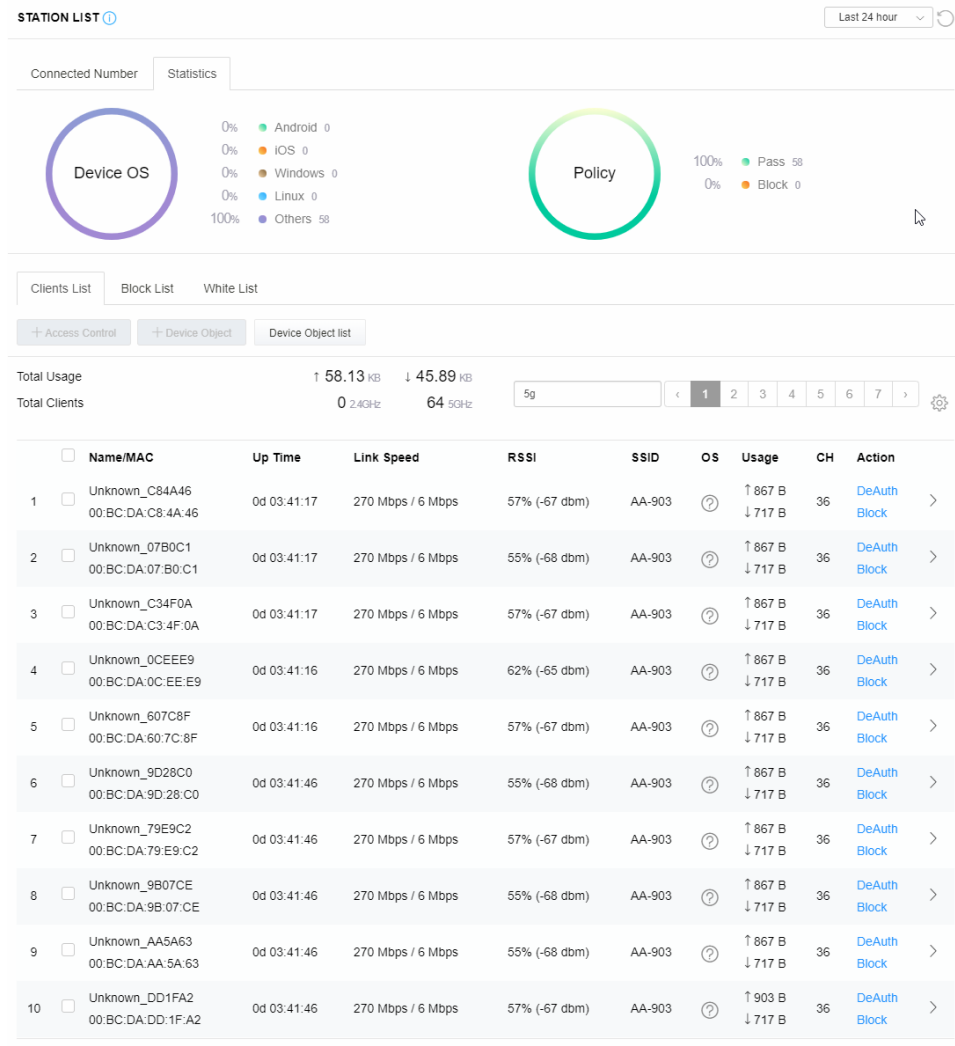

III-3-1-3 Clients List

The client list displays all the stations connecting to VigorAP.

STATION LIST ⓘ Last 24 hour ↻

Connected Number Statistics

Device OS

- 0% Android 0
- 0% iOS 0
- 0% Windows 0
- 0% Linux 0
- 100% Others 58

Policy

- 100% Pass 58
- 0% Block 0

Clients List Block List White List

+ Access Control
+ Device Object
Device Object list

Total Usage ↑ 58.13 KB ↓ 45.89 KB

Total Clients 0 2.4GHz 64 5GHz
5g
< 1 2 3 4 5 6 7 >
⚙️

<input type="checkbox"/>	Name/MAC	Up Time	Link Speed	RSSI	SSID	OS	Usage	CH	Action
<input type="checkbox"/>	Unknown_C84A46 00:BC:DA:C8:4A:46	0d 03:42:47	270 Mbps / 6 Mbps	57% (-67 dbm)	AA-903	?	↑ 867 B ↓ 717 B	36	DeAuth Block
<input checked="" type="checkbox"/>	Unknown_07B0C1 00:BC:DA:07:B0:C1	0d 03:42:47	270 Mbps / 6 Mbps	55% (-68 dbm)	AA-903	?	↑ 867 B ↓ 717 B	36	DeAuth Block
<input checked="" type="checkbox"/>	Unknown_C34F0A 00:BC:DA:C3:4F:0A	0d 03:42:47	270 Mbps / 6 Mbps	57% (-67 dbm)	AA-903	?	↑ 867 B ↓ 717 B	36	DeAuth Block
<input type="checkbox"/>	Unknown_0CEEE9 00:BC:DA:0C:EE:E9	0d 03:42:46	270 Mbps / 6 Mbps	62% (-65 dbm)	AA-903	?	↑ 867 B ↓ 717 B	36	DeAuth Block

Available settings are explained as follows:

Item	Description									
+Access Control	<p>It is available after choosing one of the entries (clients) on Clients List.</p> <div style="border: 1px solid #ccc; padding: 10px; margin: 10px 0;"> <p>Add Access Control ⓘ</p> <p>Wireless LAN 5GHz</p> <hr/> <p>SSID Policy</p> <p>1 Black list AA-903 2 Disable AA-903-2 3 Disable AA-903-3 4 Disable AA-903-4</p> <hr/> <p>From to list</p> <table style="width: 100%; border-collapse: collapse;"> <thead> <tr> <th>Device MAC</th> <th>Name</th> <th>Apply to SSID</th> </tr> </thead> <tbody> <tr> <td>00:BC:DA:07:B0:C1</td> <td>Unknown_07B0C1</td> <td><input type="checkbox"/> All <input type="checkbox"/> 1 <input type="checkbox"/> 2 <input type="checkbox"/> 3 <input type="checkbox"/> 4</td> </tr> <tr> <td>00:BC:DA:C3:4F:0A</td> <td>Unknown_C34F0A</td> <td><input type="checkbox"/> All <input type="checkbox"/> 1 <input type="checkbox"/> 2 <input type="checkbox"/> 3 <input type="checkbox"/> 4</td> </tr> </tbody> </table> <p style="font-size: small; color: red;">Total : 0/256</p> <p style="text-align: right;">Close Save changes</p> </div> <p>Wireless LAN - Specify the bandwidth for the access control list.</p> <p>SSID Policy - Set the policy for each SSID as black list or white list or disable.</p> <p>From to list - Display the clients available for applying this access</p>	Device MAC	Name	Apply to SSID	00:BC:DA:07:B0:C1	Unknown_07B0C1	<input type="checkbox"/> All <input type="checkbox"/> 1 <input type="checkbox"/> 2 <input type="checkbox"/> 3 <input type="checkbox"/> 4	00:BC:DA:C3:4F:0A	Unknown_C34F0A	<input type="checkbox"/> All <input type="checkbox"/> 1 <input type="checkbox"/> 2 <input type="checkbox"/> 3 <input type="checkbox"/> 4
Device MAC	Name	Apply to SSID								
00:BC:DA:07:B0:C1	Unknown_07B0C1	<input type="checkbox"/> All <input type="checkbox"/> 1 <input type="checkbox"/> 2 <input type="checkbox"/> 3 <input type="checkbox"/> 4								
00:BC:DA:C3:4F:0A	Unknown_C34F0A	<input type="checkbox"/> All <input type="checkbox"/> 1 <input type="checkbox"/> 2 <input type="checkbox"/> 3 <input type="checkbox"/> 4								

control.

Apply to SSID - Check **All** to make the device apply the policies to all SSIDs. Or select the one(s) to make the device apply the policies to the selected SSIDs.

Close - Exit this page without saving any changes.

Save changes - Save the changes and exit this page.

+Device Object

To add a device to device object list, choose one of the entries (clients) on Clients List to enable the Device Object button. Click the button to open the following page.

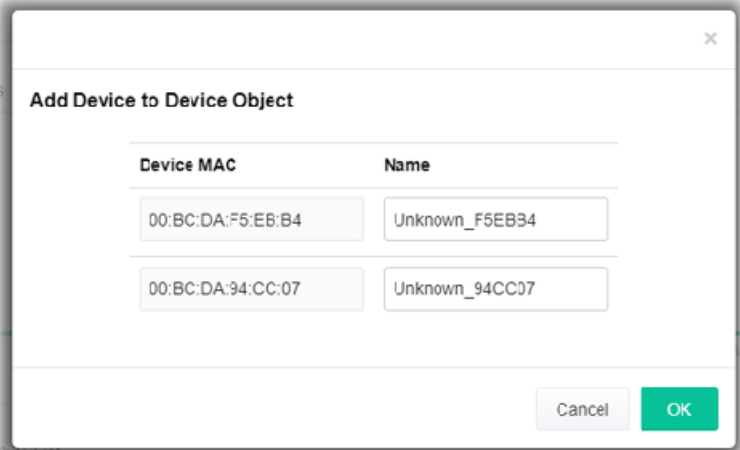

The screenshot shows a dialog box titled "Add Device to Device Object". It contains two rows of input fields. The first row has "Device MAC" with the value "00:BC:DA:F5:E6:B4" and "Name" with the value "Unknown_F5EB34". The second row has "Device MAC" with the value "00:BC:DA:94:CC:07" and "Name" with the value "Unknown_94CC07". At the bottom right, there are "Cancel" and "OK" buttons.

Check the information listed on the page. Change the MAC address or name of the selected entry if required. Then click **OK** and exit the page.

Device Object list

The existed device object profiles will be shown on the following page.



The screenshot shows a page titled "DEVICE OBJECT" with a section "Device Object Profiles". There is a search bar and a "Set to Factory Default" button. Below is a table with the following data:

Profile	MAC	Name
1	00:50:7F:F1:91:BC	TEST_1
2	00:50:7F:00:52:BA	TEST_2

Clients List

Display the stations connecting to this Vigor device.

Total Usage - Display

Total Clients - Display the number of the clients using 2.4GHz

Name / MAC - Display the host name / MAC address of the connecting client.

Up Time - Display the connection time.

Link Speed- Display the link speed.

RSSI - Display the RSSI value.

SSID - Display the SSID the client used for connecting VigorAP.

OS - Display the OS of the client.

Usage - Display the bandwidth usage (up and down) of the client.

CH - Display the channel used by the client.

Action - Display the authentication method used by the client, and if it is on block list or white list.

II-3-13-4 Block List

This page displays information of the stations under block list.

STATION LIST ⓘ Last 24 hour ↻

Connected Number Statistics

2.4 GHz ● 5 GHz ●

Clients List Block List White List

+ Access Control + Device Object Device Object list

Search ⚙️

< 1 >

	Name / MAC	SSID	Reason	Action
1	Unknown_457823 00:BC:DB:45:78:23	AA-903	ACL	Unblock
2	Unknown_A566C8 00:BC:DB:A5:66:C8	AA-903	ACL	Unblock

Total list 2

Available settings are explained as follows:

Item	Description
Device Object list	Click it to open the Device Object List dialog for reference. 
Name / MAC	Display the host name / MAC Address for the connecting client.
SSID	Display the SSID that the wireless client connects to.
Reason	Display the reference information.
Action	Display the action that you can execute for the station. Unblock - Click to unblock the entry.

III-3-1-5 White List

This page displays general information of the stations under white list.

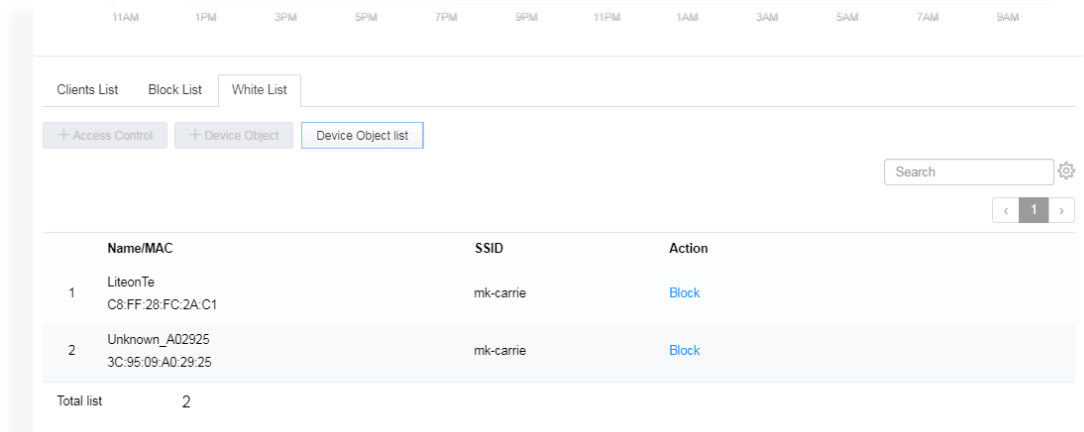

Available settings are explained as follows:

Item	Description
Device Object list	Click it to open the Device Object List dialog for reference. 
Name / MAC	Display the host name / MAC Address for the connecting client.
SSID	Display the SSID that the wireless client connects to.
Action	Display the action that you can execute for the station. Block - Click to block the entry.

III-3-2 Station Statistics

This page is used for debug or for the user to observe network traffic and network quality.

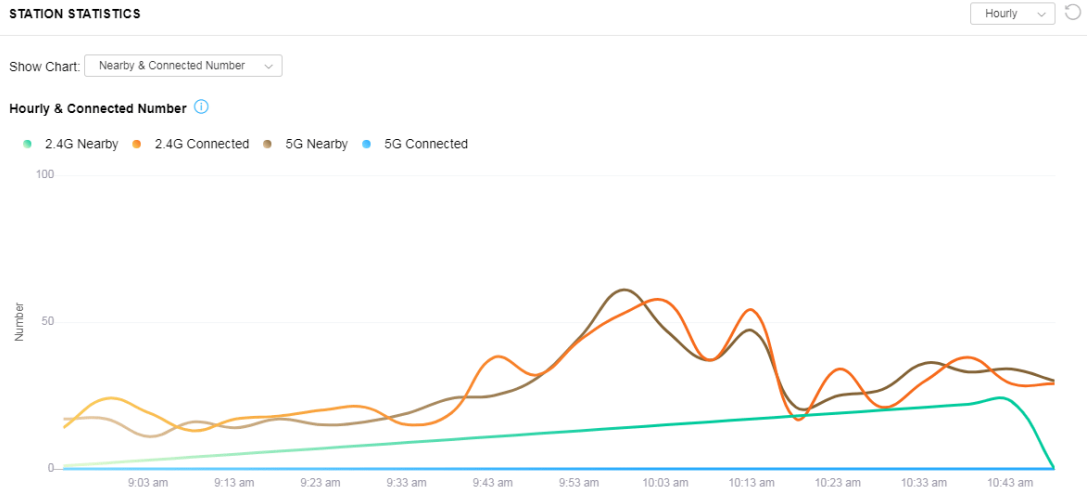

Available parameters are explained as follows:

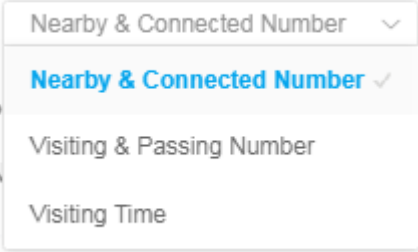
Item	Description
Show Chart	<p>Choose one of the items to display the statistics chart for wireless stations.</p>  <p>Nearby & Connected Number – Choose it to have the statistics of the wireless stations which is nearby and connected to VigorAP 918R.</p> <p>Visiting & Passing Number – Choose it to have the statistics of the wireless stations which is visiting and passing to VigorAP 918R.</p> <p>Visiting Time - Choose it to have the statistics of the wireless stations which is visiting VigorAP 918R.</p>

III-3-3 Station Nearby

This page displays the general information for the nearby stations.

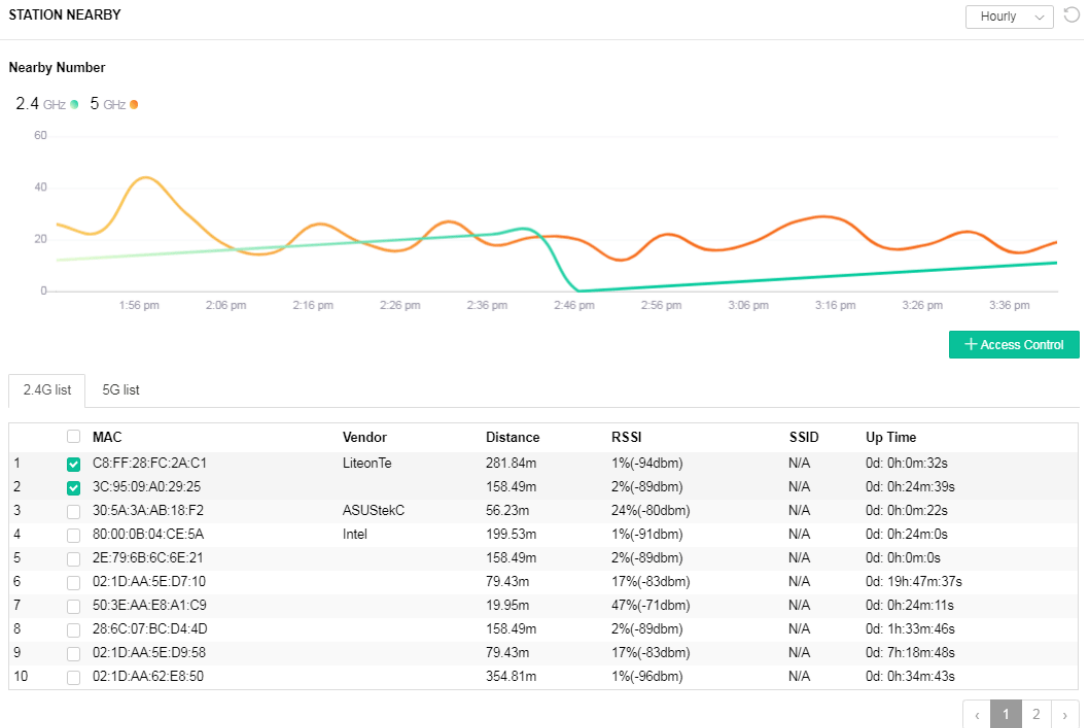

- ① 1.approx. Distance is calculated by actual signal strength of device detected. Lnaccuracy might occur based on barrier encountered.
- 2. Due to the difference in signal strength for different devices, thd calculated value of approximate distance also might be different.

You can select the station(s) and click **+Access Control** to configure the nearby stations as the one(s) to pass through VigorAP or to be blocked by VigorAP.

Add Access Control ✕

Wireless LAN 2.4GHz

SSID Policy

1 Disable 2 White list 3 Disable 4 Disable

mk-angela-903-1 mk-carrie N/A N/A

From to list

Device MAC	Name	Apply to SSID
C8:FF:28:FC:2A:C1	LiteonTe	<input checked="" type="checkbox"/> All <input checked="" type="checkbox"/> 1 <input checked="" type="checkbox"/> 2 <input checked="" type="checkbox"/> 3 <input checked="" type="checkbox"/> 4
3C:95:09:A0:29:25		<input checked="" type="checkbox"/> All <input checked="" type="checkbox"/> 1 <input checked="" type="checkbox"/> 2 <input checked="" type="checkbox"/> 3 <input checked="" type="checkbox"/> 4

Total : 0/256

Close
Save changes

Available parameters are explained as follows:

Item	Description
SSID Policy	Determine the policy (disable, white list or black list) applied for the SSID (1 to 4).
From to list	<p>Device MAC - Display the MAC address of the selected station.</p> <p>Name - Display the name of the selected station.</p> <p>Apply to SSID - Check the box(es) to apply the SSID to the selected station.</p> <p>Close - Exit the dialog without saving the changes.</p> <p>Save changes - Save the changes and exit the dialog.</p>

III-3-4 Policies

This page determines which devices (mobile, PC, MAC or others) allowed to make network connections via VigorAP or blocked by VigorAP.

Policies

Block Mobile Connections (OS:Android,iOS...)

Block PC Connections (OS:Windows,Linux,iMac...)

Block Unknown Connections (OS:Others)

WiFi(2.4GHz) SSID1 SSID2 SSID3 SSID4

WiFi(5GHz) SSID1 SSID2 SSID3 SSID4

Each item is explained as follows:

Item	Description
Block Mobile Connections	All of mobile devices will be blocked and not allowed to access into Internet via VigorAP.
Block PC Connections	All of network connections based on PC, MAC or Linux platform will be blocked and terminated.
Block Unknown Connections	Only the unknown network connections (unable to be recognized by Vigor router) will be blocked and terminated.
WiFi(2.4GHz)	Specify the SSID(s) to apply such policy.
WiFi(5GHz)	Specify the SSID(s) to apply such policy.

After finished the policy selection, click **OK**. VigorAP will *reboot* to activate the new policy automatically.

III-3-5 Station Control List

This page displays information related to the wireless stations connecting to the Vigor AP.

STATION CONTROL LIST

 ● Online ● Offline ↻

	SSID	MAC	Connection Time	Reconnection Time
1	● AP912C_117_2.4G_1	28:3A:4D:52:AC:E5	0d 00:58:50	0d 00:00:00
2	● AP912C_117_2.4G_1	20:47:DA:25:A5:6B	0d 00:48:22	0d 00:00:00
3	● AP912C_117_5G_1	40:4E:36:5E:3F:A7	0d 00:59:55	0d 00:00:00
4	● AP912C_117_5G_1	D0:37:45:34:7C:C8	0d 00:56:02	0d 00:00:00

ⓘ This page is available when [Station Control](#) is enabled.

Chapter IV Others

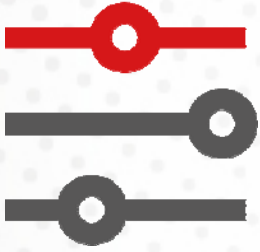

IV-1 RADIUS Setting

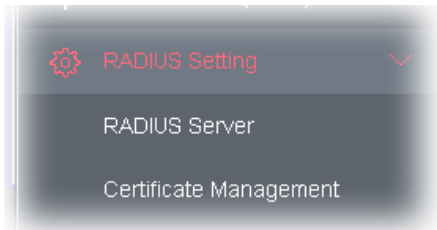

IV-1-1 RADIUS Server

VigorAP 918R offers a built-in RADIUS server to authenticate the wireless client that tries to connect to VigorAP 918R. The AP can accept the wireless connection authentication requested by wireless clients.

RADIUS Setting >> RADIUS Server Configuration

Enable RADIUS Server

Authentication Type

Radius EAP Type PEAP ▾

Users Profile (up to 96 users)

Username	Password	Confirm Password	Configure
<input type="text"/>	<input type="text"/>	<input type="text"/>	Add Cancel
NO.	Username	Select	
Delete Selected		Delete All	

Authentication Client (up to 16 clients)

Client IP	Secret Key	Confirm Secret Key	Configure
<input type="text"/>	<input type="text"/>	<input type="text"/>	Add Cancel
NO.	Client IP	Select	
Delete Selected		Delete All	

OK Cancel

Backup Radius Cfg : Upload From File:

Available settings are explained as follows:

Item	Description
Enable RADIUS Server	Check it to enable the internal RADIUS server.

Authentication Type	<p>Let the user to choose the authentication method for RADIUS server.</p> <p>Radius EAP Type – There are two types, PEAP and EAP TLS, offered for selection. If EAP TLS is selected, a certificate must be installed or must be ensured to be trusted.</p>
Users Profile	<p>Username – Type a new name for the user profile.</p> <p>Password – Type a new password for such new user profile.</p> <p>Confirm Password – Retype the password to confirm it.</p> <p>Configure</p> <ul style="list-style-type: none"> ● Add – Make a new user profile with the name and password specified on the left boxes. ● Cancel – Clear current settings for user profile. <p>Delete Selected – Delete the selected user profile (s).</p> <p>Delete All – Delete all of the user profiles.</p>
Authentication Client	<p>This internal RADIUS server of VigorAP 918R can be treated as the external RADIUS server for other users. Specify the client IP and secret key to make the wireless client choosing VigorAP 918R as its external RADIUS server.</p> <p>Client IP – Type the IP address for the user to be authenticated by VigorAP 918R when the user tries to use VigorAP 918R as the external RADIUS server.</p> <p>Secret Key – Type the password for the user to be authenticated by VigorAP 918R while the user tries to use VigorAP 918R as the external RADIUS server.</p> <p>Confirm Secret Key – Type the password again for confirmation.</p> <p>Configure</p> <ul style="list-style-type: none"> ● Add – Make a new client with IP and secret key specified on the left boxes. ● Cancel – Clear current settings for the client. <p>Delete Selected – Delete the selected client(s).</p> <p>Delete All – Delete all of the clients.</p>
Backup Radius Cfg	<p>Backup - Click to store the configuration set on this page as a file.</p>
Upload From File	<p>Upload - Click to upload the RADIUS configuration file from the host to VigorAP.</p> <p>Restore - Click to restore the RADIUS configuration file to VigorAP.</p>

After finishing this web page configuration, please click **OK** to save the settings.

IV-1-2 Certificate Management

When the local client and remote server are required to make certificate authentication (e.g., Radius EAP-TLS authentication) for wireless connection and avoiding the attack of MITM, a trusted root certificate authority (Root CA) will be used to authenticate the digital certificates offered by both ends.

However, the procedure of applying digital certificate from a trusted root certificate authority is complicated and time-consuming. Therefore, Vigor AP offers a mechanism which allows you to generate root CA to save time and provide convenience for general user. Later, such root CA generated by DrayTek server can perform the issuing of local certificate.

Root CA can be deleted but not edited. If you want to modify the settings for a Root CA, please delete the one and create another one by clicking Create Root CA.

RADIUS Setting >> X509 Trusted CA Certificate Configuration

Name	Subject	Status	Modify
Root CA	---	---	Create Root CA

Note: 1. Please setup the "System Maintenance >> [Time and Date](#)" correctly before you try to generate a RootCA.
2. The Time Zone MUST be setup correctly.

Click **Create Root CA** to open the following page. Type or choose all the information that the window request such as subject name, key type, key size and so on.

RADIUS Setting >> Create Root CA

Certificate Name	Root CA
Subject Name	
Country (C)	<input type="text"/>
State (S)	<input type="text"/>
Location (L)	<input type="text"/>
Organization (O)	<input type="text"/>
Organization Unit (OU)	<input type="text"/>
Common Name (CN)	<input type="text"/>
Email (E)	<input type="text"/>
Key Type	
	RSA <input type="button" value="v"/>
Key Size	
	1024 Bit <input type="button" value="v"/>
Apply to Web HTTPS	
	<input type="checkbox"/>

Available settings are explained as follows:

Item	Description
Subject Name	Type the required information for creating a root CA. Country (C) – Type the country code (two characters) in this box. State (S)/ Location (L)/ Organization (O)/ Organization Unit (OU) /Common Name (CN) - Type the name or information for the root CA with length less than 32 characters. Email (E) – Type the email address for the root CA with length less than 32 characters.
Key Type	At present, only RSA (an encryption algorithm) is supported by such device.

Key Size	To determine the size of a key to be authenticated, use the drop down list to specify the one you need.
Apply to Web HTTPS	VigorAP needs a certificate to access into Internet via Web HTTPS. Check this box to use the user-defined root CA certificate which will substitute for the original certificate applied by web HTTPS.

 **Note:**

“Common Name” must be configured with router’s WAN IP or domain name.

After finishing this web page configuration, please click **OK** to save the settings. A new root CA will be generated.

IV-2 Applications

Below shows the menu items for Applications.

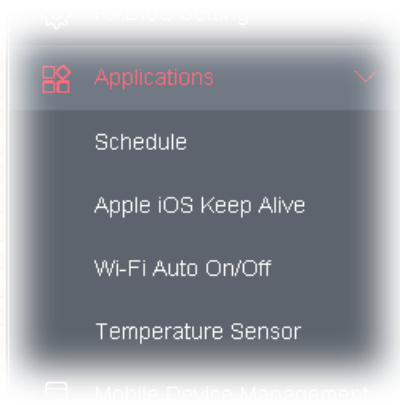

IV-2-1 Schedule

The VigorAP has a built-in clock which can update itself manually or automatically by means of Network Time Protocols (NTP). As a result, you can not only schedule the AP to dialup to the Internet at a specified time, but also restrict Internet access to certain hours so that users can connect to the Internet only during certain hours, say, business hours. The schedule is also applicable to other functions.

You have to set your time before set schedule. In **System Maintenance>> Time and Date** menu, press **Inquire Time** button to set the VigorAP's clock to current time of your PC. The clock will reset once if you power down or reset the AP. There is another way to set up time. You can inquiry an NTP server (a time server) on the Internet to synchronize the AP's clock. This method can only be applied when the WAN connection has been built up.

Applications >> Schedule

Schedule : Current System Time

| [System time set](#) | [Set to Factory Default](#) |

Index Enable Name Action Time ● Active ● Finished ● Not reached Frequency

OK

Add

Available settings are explained as follows:

Item	Description
Current System Time	Display current system time.
System time set	Click it to open Time and Date page for configuring the time setting.
Set to Factory Default	Click it to return to the factory default setting and remove all the schedule profiles.
Index	Display the sort number of the schedule profile.
Enable	Check it to enable the function of schedule configuration.

Name	Display the name of the schedule.
Action	Display the action adopted by the schedule profile.
Time	Display the time setting of the schedule.
Frequency	Display the frequency of the time schedule.

You can set up to **15** schedules. To add a schedule:

1. Check the box of **Enable Schedule**.
2. Click the **Add** button to open the following web page.

Applications >> Schedule

Add Schedule

Enable

Name

Start Date - - (Year - Month - Day)

Start Time : (Hour : Minute)

Duration Time : (Hour : Minute)

End Time : (Hour : Minute)

Action

WiFi(2.4GHz) Radio SSID2 SSID3 SSID4

WiFi(5GHz) Radio SSID2 SSID3 SSID4

schedule how often

Weekday Monday Tuesday Wednesday Thursday Friday Saturday Sunday

Note: 1. If we set WiFi schedule "Start Time" and "End Time" at exact same time, AP will execute the schedule without an end time.
 2. "Internet Pause" will add Mac into ACL, so please make sure ACL isn't full before applying schedule.If ACL policy is "Disable", AP will change it to "Blocked".

Available settings are explained as follows:

Item	Description
Enable	Check to enable such schedule profile.
Start Date	Specify the starting date of the schedule.
Start Time	Specify the starting time of the schedule.
Duration Time	Specify the duration (or period) for the schedule. It is available only for the action set with WIFI UP, WIFI Down, or Internet Pause.
End Time	Display the ending time (sum of start time and duration time) of the schedule.

Action	Specify which action should apply the schedule.
WiFi(2.4GHz)/ WiFi(5GHz)	When Wi-Fi UP or Wi-Fi DOWN is selected as Action , you can check the Radio or SSID 2~4 boxes (2.4GHz and 5GHz respectively) to setup the network based on the schedule profile. Note: When Radio is selected, SSID2, SSID3 and SSID4 are not available for choosing, vice versa. Moreover, SSID2, SSID3, and SSID4 are not available for choosing if they are not enabled.
Acts	Specify how often the schedule will be applied. Once -The schedule will be applied just once Routine -Specify which days in one week should perform the schedule.
Weekday	Choose and check the day to perform the schedule. It is available when Routine is selected as Acts .

- After finishing this web page configuration, please click **OK** to save the settings. A new schedule profile has been created and displayed on the screen.

Applications >> Schedule

Schedule : Current System Time | [System time set](#) | [Set to Factory Default](#) |

Index	Enable	Name	Action	Time	Frequency
1	<input checked="" type="checkbox"/>	Formkt	Auto Reboot	01:01	Once

● Active
 ● Finished
 ● Not reached

IV-2-2 Apple iOS Keep Alive

To keep the wireless connection (via Wi-Fi) on iOS device in alive, VigorAP 918R will send the UDP packets with 5353 port to the specific IP every five seconds.

Applications >> Apple iOS Keep Alive

Enable Apple iOS Keep Alive

Apple iOS Keep Alive:
Apple iOS Keep Alive can keep Wifi connection of iOS device by sending UDP port 5353 packets every 5 seconds.

Index	Apple iOS Keep Alive IP Address	Index	Apple iOS Keep Alive IP Address
1		2	
3		4	
5		6	

Available settings are explained as follows:

Item	Description
Enable Apple iOS Keep Alive	Check to enable the function.

Index	Display the setting link. Click the index link to open the configuration page for setting the IP address.
Apple iOS Keep Alive IP Address	Display the IP address.

Click **OK** to save the settings.

IV-2-3 Wi-Fi Auto On/Off

When VigorAP is able or unable to ping the specified host, the Wi-Fi function will be turned on or off automatically. The purpose of such function is to avoid wireless station roaming to an AP which is unable to access Internet.

Applications >> Wi-Fi Auto On/Off

Wi-Fi Auto On/Off

Enable Connection Detection

Ping Host

When the AP is unable to ping the host:
 Turn on/off the Wi-Fi automatically when the AP is able/unable to ping the host.
 When the AP is unable to ping the host:

Wi-Fi:

LED:

OK

Available settings are explained as follows:

Item	Description
Enable Connection Detection	Check the box to enable this function.
Ping Host	Enter an IP address (e.g., 8.8.8.8) or a domain name (e.g., google.com) for testing if the access point is stable or not.
Wi-Fi	<p>Off - When VigorAP is unable to ping the host, disconnect the Wi-Fi network.</p> <p>No Change - Wi-Fi network will keep the original state (no matter on or off) even VigorAP is unable to ping the host.</p>
LED	<p>Off - When VigorAP is unable to ping the host, the LED (2.4G/5G) will be off automatically.</p> <p>No Change - When VigorAP is unable to ping the host, the LED (2.4G/5G) will keep the original state (no matter on or off).</p>

Click **OK** to save the settings.

IV-2-4 Sensor

A USB Thermometer is now available that complements your installed DrayTek AP installations that will help you monitor the server or data communications room environment and notify you if the server room or data communications room is overheating.



During summer in particular, it is important to ensure that your server or data communications equipment are not overheating due to cooling system failures.

The inclusion of a USB thermometer in compatible VigorAP will continuously monitor the temperature of its environment. When a pre-determined threshold is reached you will be alerted via Syslog.

Temperature Sensor Settings

Applications >> Sensor Setting

Sensor Graph | **Sensor Settings**

Enable "Sensor Graph"

Alerts via "Alert Method" when any sensor value is outside of "Alert Criteria" range

Alert Method

Syslog Mail

Alert Criteria

: ~ °C , calibration/current val:

°F

Humidity Sensor: ~ % , calibration/current val:

OK

Note:

1. Wi-Fi temperature is only available when the selected Wi-Fi is enabled

Available settings are explained as follows:

Item	Description
Enable "Sensor Graph"	Check it to display the sensor graph on Applications >> Sensor Setting >> Sensor Graph .
Alerts once/per min via	It can determine the time/interval to send an alert message. Once – An alert will be sent out once when the sensor value is outside the range defined in Alert Criteria. Per min. – Alert message will be sent out per minute when the sensor value is outside the range defined in Alert Criteria.
Alert Method	Syslog - The log containing the alarm message will be recorded on Syslog if it is enabled. Mail - The log containing the alarm message will be sent by mail.
Alert Criteria	Alert message will be sent out according to the rules specified in this field. Inside case - The temperature reading is obtained just from the data recorded inside the chip of VigorAP. 2.4GHz Wi-Fi - The temperature reading for 2.4G Wi-Fi network operation is estimated by using 2.4GHz CPU Wi-Fi module. The built-in sensor of VigorAP contains temperature sensor. Please type the upper limit and lower limit for VigorAP system to send out temperature alert. <ul style="list-style-type: none"> ● Calibration / current val- Type values used for correcting the temperature error. ● C°/F° - Choose the display unit of the temperature. There are two types for you to choose. Humidity Sensor - Specify a range.

Temperature Sensor Graph

Below shows an example of temperature graph:

Applications >> Sensor Graph

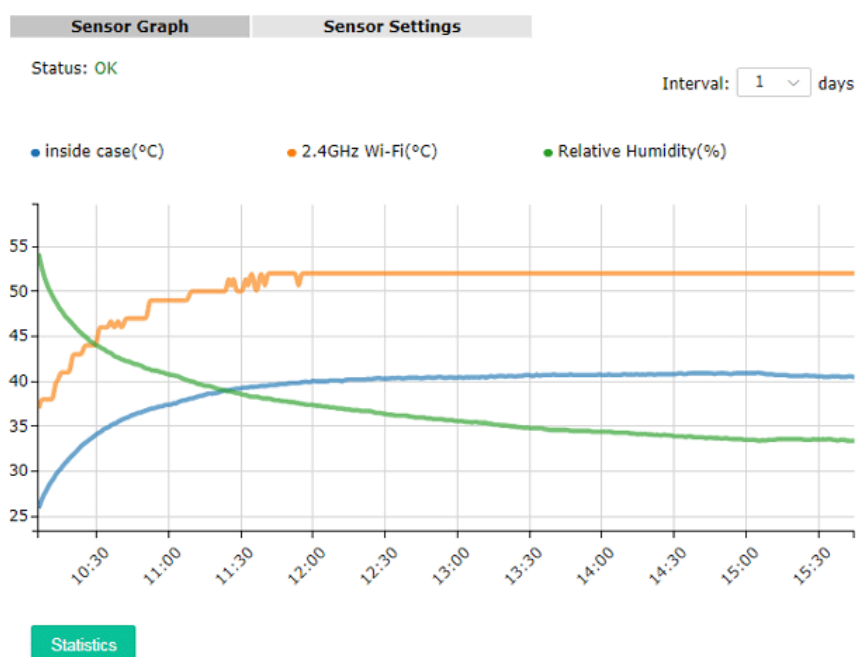

IV-3 Objects Setting

Below shows the menu items for Objects Setting.

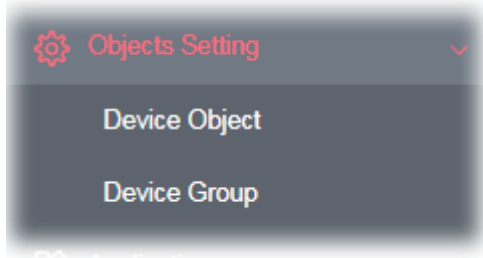

IV-3-1 Device Object

VigorAP can specify a client as a device object to be used by other applications.

Objects Setting >> Device Object

- [Create from Wireless Station Table](#)
- [Create from Wireless Neighbor Table](#)
- [Create from ARP Table](#)

Device Object Profiles [Set to Factory Default](#)

Index	MAC	Name	Index	MAC	Name
1			17		
2			18		
3			19		
4			20		
5			21		
6			22		
7			23		
8			24		
9			25		
10			26		
11			27		
12			28		
13			29		
14			30		
15			31		
16			32		

<< 1-32 | 33-64 | 65-96 | 97-128 | 129-160 | 161-192 | 193-224 | 225-256 >> [Next >>](#)

Available settings are explained as follows:

Item	Description
Create from Wireless Station Table	<p>Click the link to open the following page.</p> <p>Choose the one(s) you want and click OK. The selected entries will be</p>

	listed on the Device Object Profiles.
Create from Wireless Neighbor Table	<p>Click the link to open the following page.</p> <p>Objects Setting >> Device Object</p>  <p>Choose the one(s) you want and click OK. The selected entries will be listed on the Device Object Profiles.</p>
Create from ARP Table	<p>Click the link to open the following page.</p> <p>Objects Setting >> Device Object</p>  <p>Choose the one(s) you want and click OK. The selected entries will be listed on the Device Object Profiles.</p>
Set to Factory Default	Click it to return to the factory default setting and remove all the device object profiles.
Index	Display the index number of device object profile.
MAC	Display the MAC address specified by the device object profile.
Name	Display the name of the device object profile.

In addition to choosing from the wireless station table, neighbor table or ARP table, you can click any index number link to create a new device object profile by entering the name and MAC address manually.

Objects Setting >> Device Object

Profile Index : 1

Name :

Mac Address :

Attribute : Isolate LAN exception

Item	Description
Name	Enter the name of the profile.
Mac Address	Enter the MAC address of the client.
Attribute	Check the box to ignore the function of Isolate LAN.

OK	Save the settings.
Clear	Remove the settings.
Cancel	Discard the settings and return to previous page.

IV-3-3 Device Group

Clients can be integrated as a group and be used by other applications.

Objects Setting >> Device Group

Device Group Table		Set to Factory Default	
Index	Name	Index	Name
1		17	
2		18	
3		19	
4		20	
5		21	
6		22	
7		23	
8		24	
9		25	
10		26	
11		27	
12		28	
13		29	
14		30	
15		31	
16		32	

Available settings are explained as follows:

Item	Description
Set to Factory Default	Click it to return to the factory default setting and remove all the device group profiles.
Index	Display the index number of the device group profile.
Name	Display the name of the device group profile.

Click any index number link to create a new device group profile.

Profile Index : 1

Name :

Available Device Objects

3 - ASUSTekC

4 - 192_168_1_10

>>

<<

Selected Device Objects

1 - TEST_1

2 - LiteonTe

OK
Clear
Cancel

Available settings are explained as follows:

Item	Description
Name	Enter the name of the new group profile.
Available Device Objects	Display current available device objects. Choose the one(s) and click the >> button to move them under the Selected IP Objects.
Selected Device Objects	Display the selected device objects. Choose the one(s) and click the << button to discard the selections.
OK	Save the settings.
Clear	Remove the settings.
Cancel	Discard the settings and return to previous page.

Chapter V Mobile APP, DrayTek Wireless



V-1 Introduction of DrayTek Wireless

VigorAP AP918R supports Android/iOS APP : DrayTek Wireless. The mobile user can find the APP through Apple Store / Android APP.

After downloading the APP, a mobile user is able to access and login the configuration page of VigorAP. It can be used to set up or check status of VigorAP device in different Operation Mode.

- To access into the VigorAP configured previously, please refer to [**V-2 Select a VigorAP**](#)
- To access into a new installed VigorAP, please refer to [**V-3 Quick Start Wizard**](#)

Note:

Before using the DrayTek Wireless APP, please **ENABLE** your Wi-Fi feature first. Then, select the Wi-Fi network with Vigor access point(s) connected physically.

It is not necessary to connect to VigorAP physically. The mobile user must connect to one network with the same subnet as the VigorAP.

V-2 Select a VigorAP

1. Run DrayTek Wireless APP.

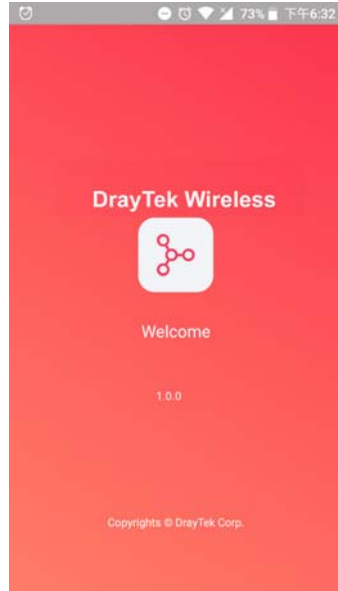

2. Choose one AP in the network by clicking the inverted triangle icon to open a drop down list.

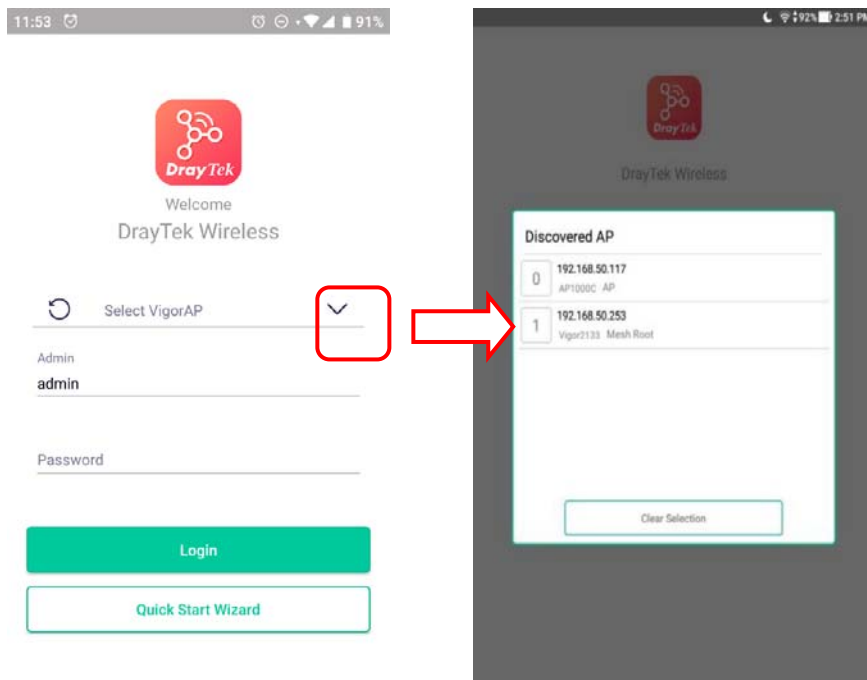

Available VigorAP devices with Model Name, IP and Operation mode of VigorAP found by DrayTek Wireless APP will be listed under **Discovered VigorAP**. Choose one of the devices to login (or use Quick Start Wizard function).

If no AP is found, Quick Start Wizard will start with Wi-Fi connection or start with wizard procedure directly.

V-3 Quick Start Wizard

Quick Start Wizard in Wireless APP is useful for connecting an new installed AP and configuring with different Operation Mode.

How to create a Mesh Group?

1. Click **Quick Start Wizard**.

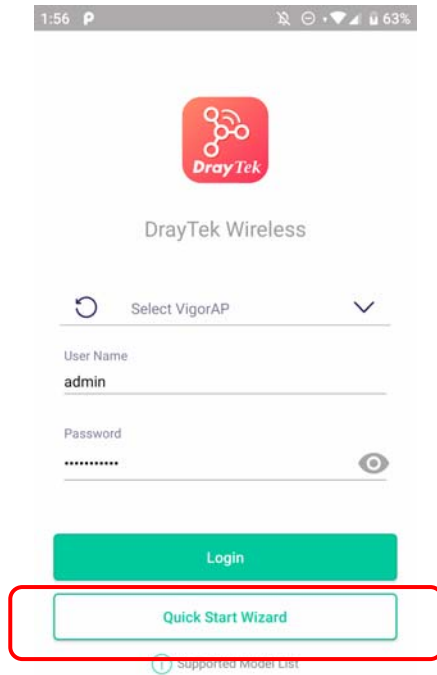

2. Under Quick Start Wizard, there are two methods to locate a mesh root, Search and Scan,
 - Click **Scan** to scan the QR code printed on VigorAP packaging box to connect the designated VigorAP.

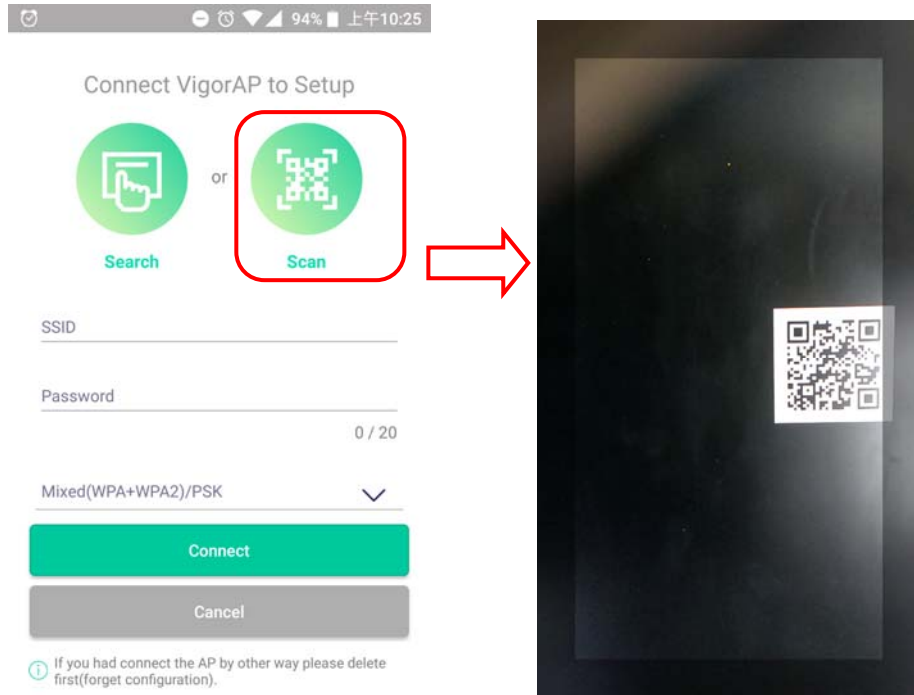

- Or, click **Search**. When the searching result appears, choose one of the AP devices to connect.

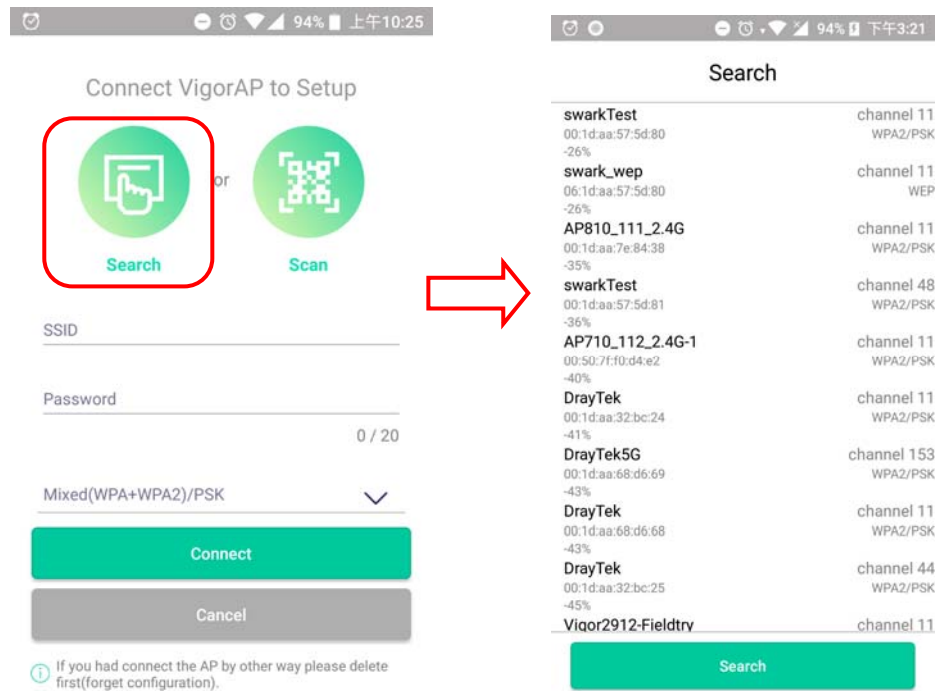

- When the following page appears, enter the password for the VigorAP device. Then, click **Connect**.

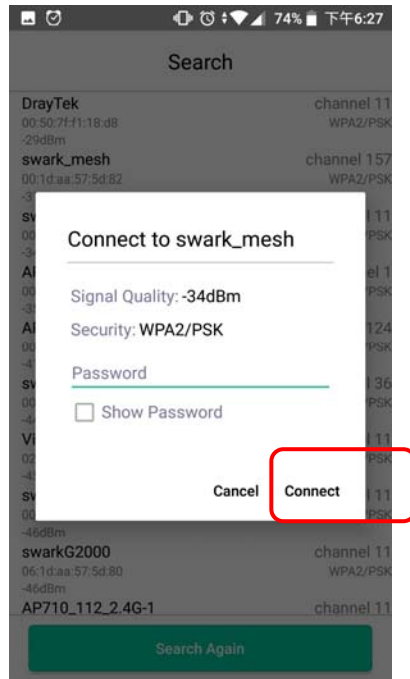

- When the connection is successful, click **Next**. Then, set Operation Mode of VigorAP as **Mesh Root** and click **Next**.

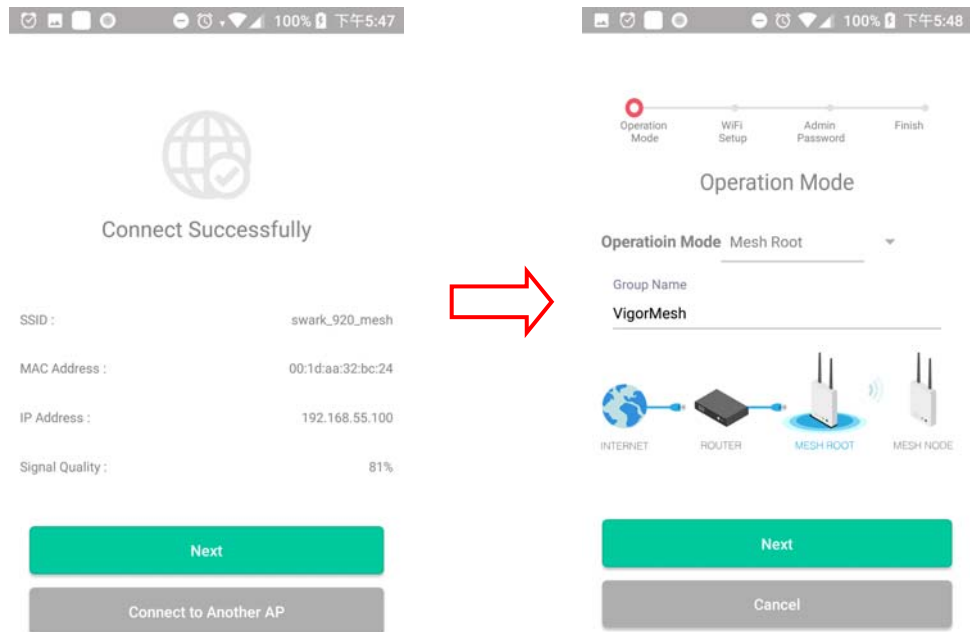

5. In the following page, set the WiFi Name (SSID) and WiFi Password for your network. You can also enable 2nd SSID by enabling the function of 2nd WiFi. Then, click **Next**.

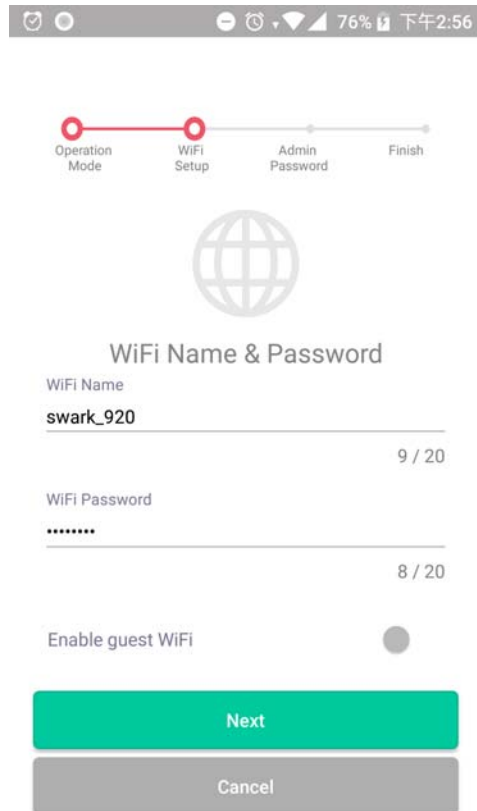

Operation Mode WiFi Setup Admin Password Finish

WiFi Name & Password

WiFi Name
swark_920
9 / 20

WiFi Password
.....
8 / 20

Enable guest WiFi

Next

Cancel

6. Change the default admin password for the network security and click **Next**.

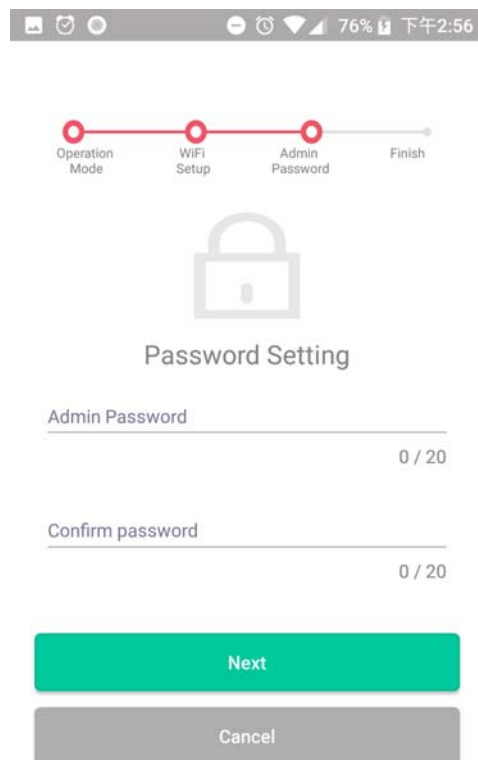

Operation Mode WiFi Setup Admin Password Finish

Password Setting

Admin Password
0 / 20

Confirm password
0 / 20

Next

Cancel

7. In the page of **Check and Apply**, click **Finish** to apply the settings to the specified VigorAP.

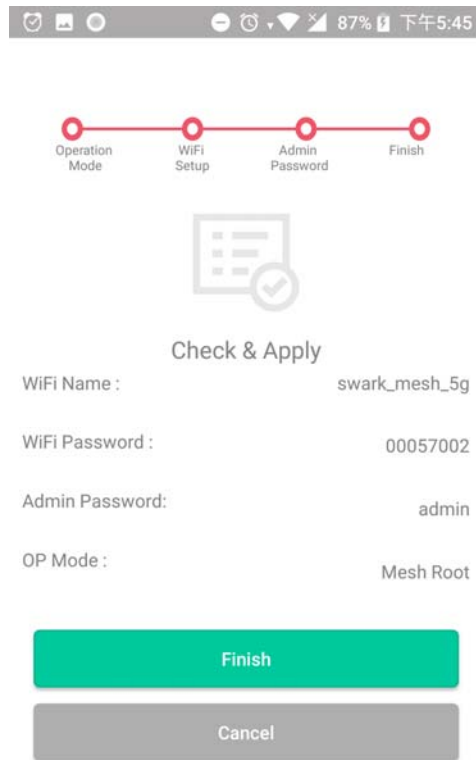

8. After sending configuration to VigorAP, it will take some time to take effect. DrayTek Wireless APP will try to reconnect to wireless network again. Please wait for a while here.

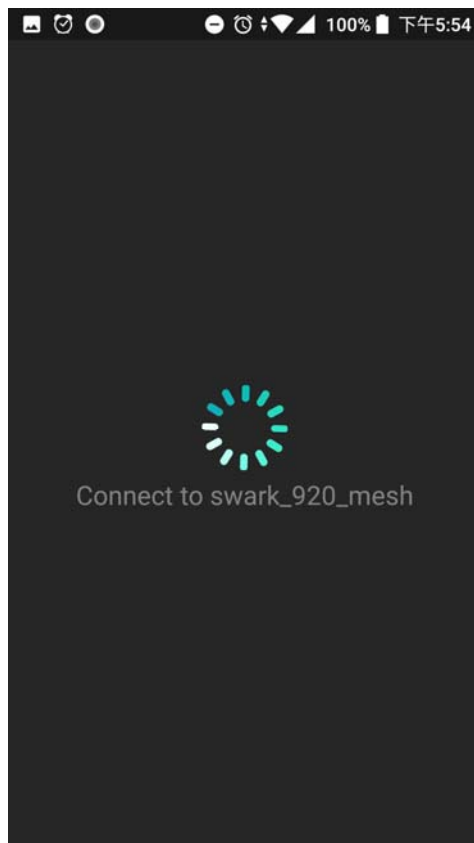

9. Now, the VigorAP has been set as Mesh Root. You can search several Mesh Nodes which do not belong to any other mesh group by clicking **Next**.

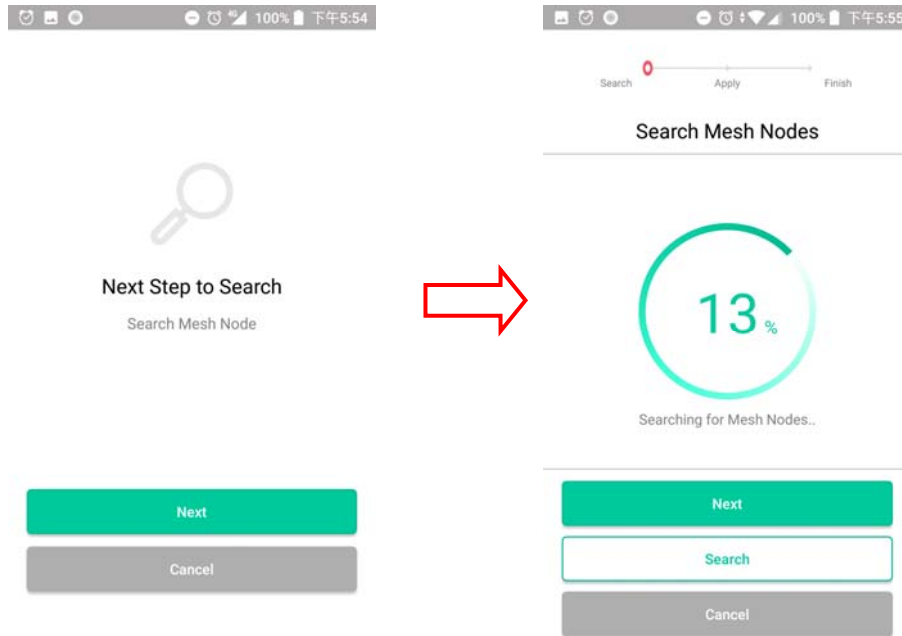

Or, click **Cancel** to return to the home page. Then, click **Add Nodes** to search several Mesh Nodes which do not belong to any other mesh group.

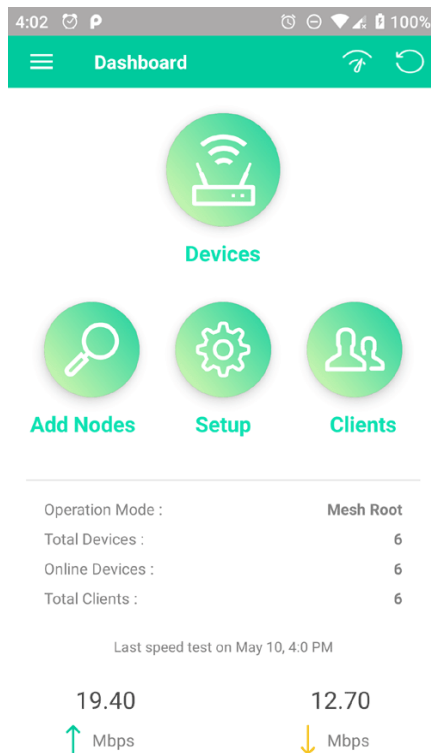

10. Later, available VigorAP devices will be shown on the page. Choose the Mesh Node you want to add and give a device name (e.g., VigorAP920R) for it. The selected mesh node(s) will be grouped under such mesh root. Click **Next**.

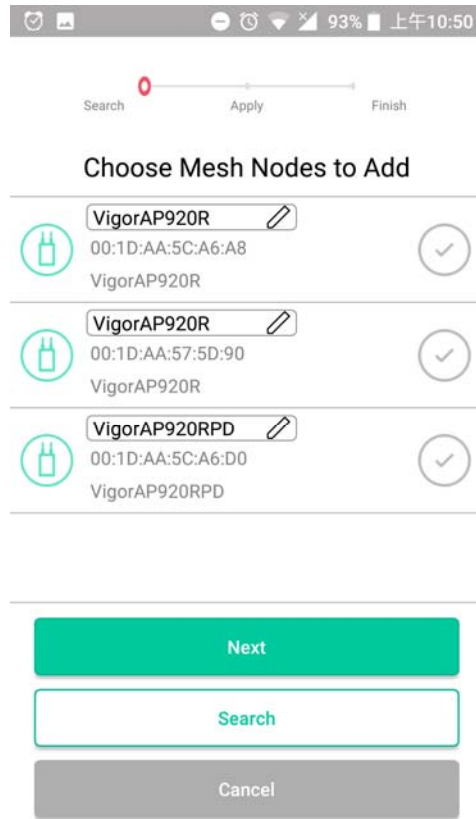

11. The following page displays the total number of mesh nodes selected. Click **Apply**.

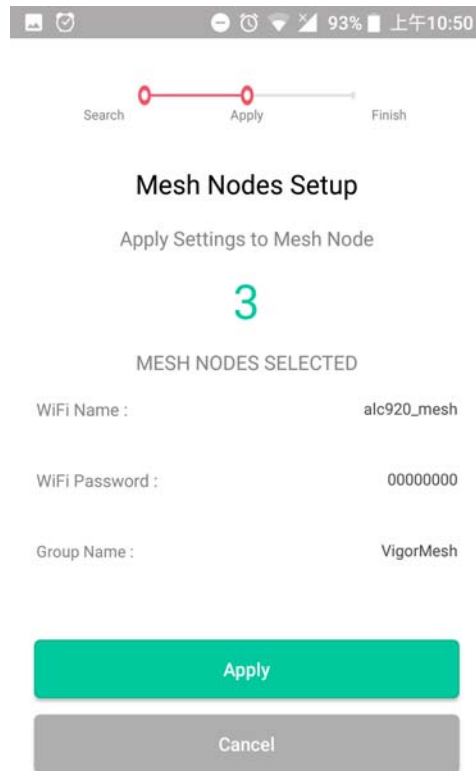

12. Wait until the mesh root applies general configuration to the mesh nodes.



13. Later, current status of the mesh node(s) will be shown on the following page. Click **Finish**.



14. Now, the main page of VigorAP APP will be displayed as follows.

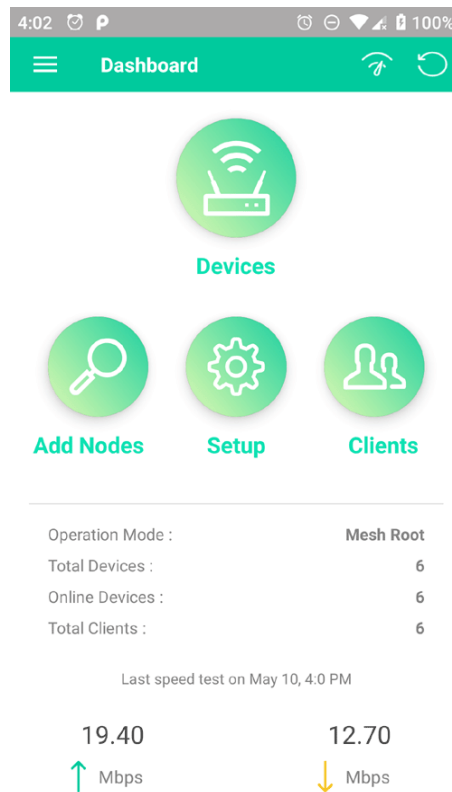

V-4 Login

The main page of VigorAP APP will be different slightly according to the operation mode of VigorAP.

After login to one AP with **Mesh Root**, the major information will be shown as follows:

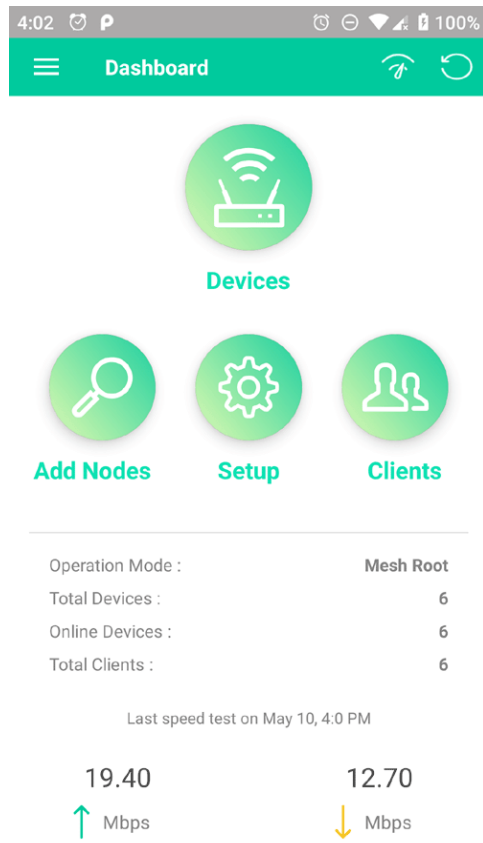

After login to one AP with **AP mode**, the major information will be shown as follows:

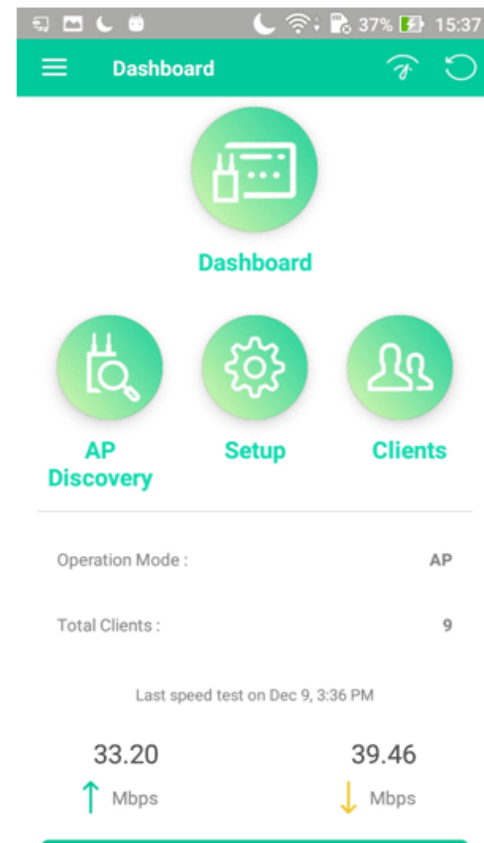

Available settings are explained as follows:

Item	Description
Devices / Dashboard	<p>Dashboard - The dashboard is designed with Responsive Web Design. You can click Dashboard to connect to the selected VigorAP WUI.</p> <p>Devices - All of the devices (mesh root and mesh nodes) controlled by the mesh group will be shown on this page with hop number. One mesh group contains up to eight devices.</p>



Add Nodes / AP Discovery

Add Nodes - Click it to add a new mesh node to this mesh group.
AP Discovery - Click it to search another access point.

Setup

Click it to configure TR069, Manage and WLAN settings for the connected VigorAP.



Setup Devices





TR069



Manage



WLAN

<p>Clients</p>	<p>Displays general information for all clients in Mesh Group or all clients connected to the selected AP (non-mesh device).</p> 
<p>Operation Mode</p>	<p>Display the operation mode (e.g., Mesh Root, AP, Mesh Node) of this AP.</p>
<p>Total Devices</p>	<p>Display the number of the total devices grouped under this mesh group.</p>
<p>Online Devices</p>	<p>Display current online devices grouped under this mesh group.</p>
<p>Total Clients</p>	<p>Display the number of the total clients connected to the mesh group or the selected AP (non-mesh device).</p>
<p> (Speed test)</p>	<p>Click it to make a speed test for the mesh group / AP.</p>
<p>Logout</p>	<p>Exit this APP.</p>

This page is left blank.

Chapter VI Troubleshooting



V-1 Diagnostics

This section will guide you to solve abnormal situations if you cannot access into the Internet after installing the router and finishing the web configuration. Please follow sections below to check your basic installation status stage by stage.

- Checking if the hardware status is OK or not.
- Checking if the network connection settings on your computer are OK or not.
- Pinging the router from your computer.
- Checking if the ISP settings are OK or not.
- Backing to factory default setting if necessary.

If all above stages are done and the router still cannot run normally, it is the time for you to contact your dealer or DrayTek technical support for advanced help.

Dagnostic tools provide a useful way to **view** or **diagnose** the status of your VigorAP 918R.

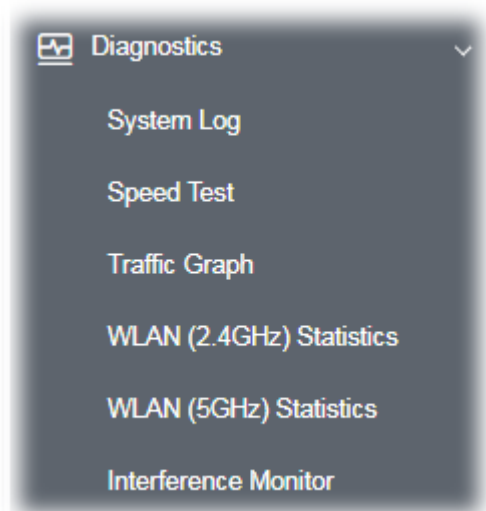

V-1-1 System Log

At present, only **System Log** is offered.

Diagnostics >> System Log

System Log Information

| [Clear](#) | [Refresh](#) | [Line wrap](#) |

```
Aug 27 09:26:25 syslog: [APM] Get Traffic data.
Aug 27 09:26:26 syslog: [APM] Request done.
Aug 27 09:30:01 syslog: @DRAY_BAND_INFO : Mon Aug 27 09:30:01 2018 (1535333401)^
Aug 27 09:31:26 syslog: [APM] Get Traffic data.
Aug 27 09:31:26 syslog: [APM] Request done.
Aug 27 09:36:27 syslog: [APM] Get Traffic data.
Aug 27 09:36:27 syslog: [APM] Request done.
Aug 27 09:40:01 syslog: @DRAY_BAND_INFO : Mon Aug 27 09:40:01 2018 (1535334001)^
Aug 27 09:41:28 syslog: [APM] Get Traffic data.
Aug 27 09:41:28 syslog: [APM] Request done.
Aug 27 09:41:38 kernel: APPeerProbeReqAction():shiang! PeerProbeReqSanity failed!
Aug 27 09:41:38 kernel: APPeerProbeReqAction():shiang! PeerProbeReqSanity failed!
Aug 27 09:46:29 syslog: [APM] Get Traffic data.
Aug 27 09:46:29 syslog: [APM] Request done.
Aug 27 09:50:01 syslog: @DRAY_BAND_INFO : Mon Aug 27 09:50:01 2018 (1535334601)^
Aug 27 09:51:30 syslog: [APM] Get Traffic data.
```

V-1-2 Speed Test

Click the **Start** button on the page to test the speed. Such feature can help you to find the best installation place for Vigor AP.

Diagnostics >> Speed Test

Speed Test

Welcome to VigorAP918R Speed Test.

This test allows you to find out the best place for VigorAP918R. You can execute the speed test at different places of the building and select the best location for it. The performance test result is only for your reference.

[Start](#)

V-1-3 Traffic Graph

Click **Traffic Graph** to open the web page. Choose one of the managed Access Points, LAN-A or LAN-B, daily or weekly for viewing data transmission chart. Click **Refresh** to renew the graph at any time.

Diagnostics >> Traffic Graph

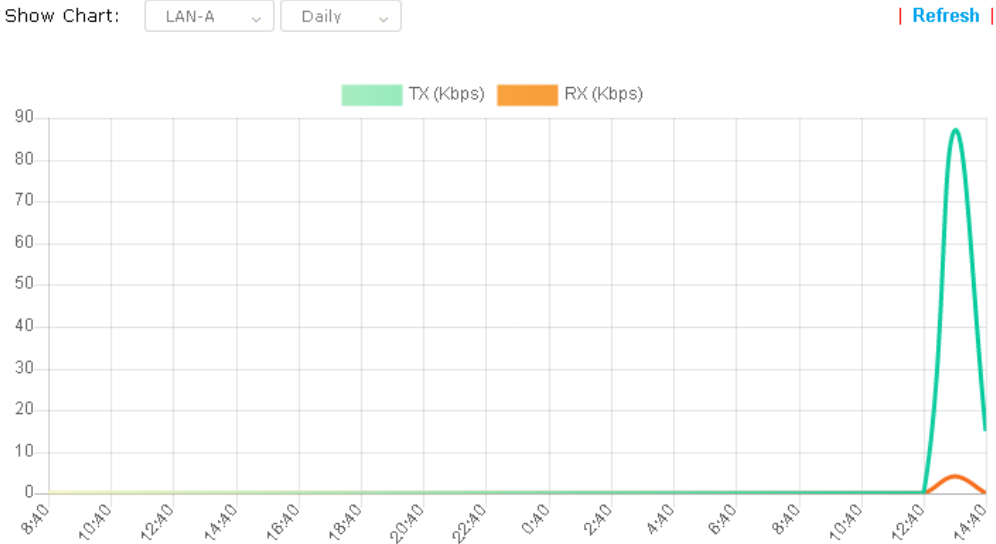

The horizontal axis represents time; the vertical axis represents the transmission rate (in kbps).

V-1-4 WLAN (2.4GHz) Statistics

Such page is used for debug by RD only.

Diagnostics >> WLAN (2.4GHz) Statistics

Auto-Refresh

Refresh

Tx Data Packets	0	Rx Data Packets	0
Tx Data Bytes	0	Rx Data Bytes	0
Average Tx Rate (kbps)	No Station	Average Rx Rate (kbps)	No Station
Tx Unicast Data Packets	0	Rx PHY errors	0
Tx Multi/Broadcast Data Packets	0	Rx CRC errors	81483
Tx failures	0	Rx MIC errors	0
		Rx Decryption errors	0
		Rx errors	0
	SSID1 (DrayTek-3FB230)	SSID2 (mk_carrie)	SSID3 (N/A)
	SSID4 (N/A)		
Tx Data Packets	0	0	N/A
Tx Data Bytes	0	0	N/A
Tx Data BytesTx Data Payload Bytes	0	0	N/A
Rx Data Packets	0	0	N/A
Rx Data Bytes	0	0	N/A
Rx Data Payload Bytes	0	0	N/A
Tx Unicast Data Packets	0	0	N/A
Tx Multi/Broadcast Data Packets	0	0	N/A
Average Tx Rate (kbps)	No Station	No Station	N/A
Average Rx Rate (kbps)	No Station	No Station	N/A
Rx errors	0	0	N/A
Tx failures	0	0	N/A

V-1-5 WLAN (5GHz) Statistics

Such page is used for debug by RD only.

Diagnostics >> WLAN (5GHz) Statistics

Auto-Refresh

Refresh

Tx Data Packets	0	Rx Data Packets	0
Tx Data Bytes	0	Rx Data Bytes	0
Average Tx Rate (kbps)	No Station	Average Rx Rate (kbps)	No Station
Tx Unicast Data Packets	0	Rx PHY errors	0
Tx Multi/Broadcast Data Packets	0	Rx CRC errors	20006
Tx failures	0	Rx MIC errors	0
		Rx Decryption errors	0
		Rx errors	0
	SSID1 (DrayTek-3FB230)	SSID2 (mk_carrie)	SSID3 (N/A)
	SSID4 (N/A)		
Tx Data Packets	0	0	N/A
Tx Data Bytes	0	0	N/A
Tx Data BytesTx Data Payload Bytes	0	0	N/A
Rx Data Packets	0	0	N/A
Rx Data Bytes	0	0	N/A
Rx Data Payload Bytes	0	0	N/A
Tx Unicast Data Packets	0	0	N/A
Tx Multi/Broadcast Data Packets	0	0	N/A
Average Tx Rate (kbps)	No Station	No Station	N/A
Average Rx Rate (kbps)	No Station	No Station	N/A
Rx errors	0	0	N/A
Tx failures	0	0	N/A

V-1-6 Interference Monitor

As an interference detector, VigorAP can detect all of the environmental interference factors for certain channel used or for all of the wireless channels.

Current Channel

The analysis page with information about wireless band, channel, transmission power, bandwidth, wireless mode, and country code chosen will be displayed on this page completely based on the wireless band (2.4G or 5G) selected. Also, channel status can be seen easily from this page.

Diagnostics >> Interference Monitor

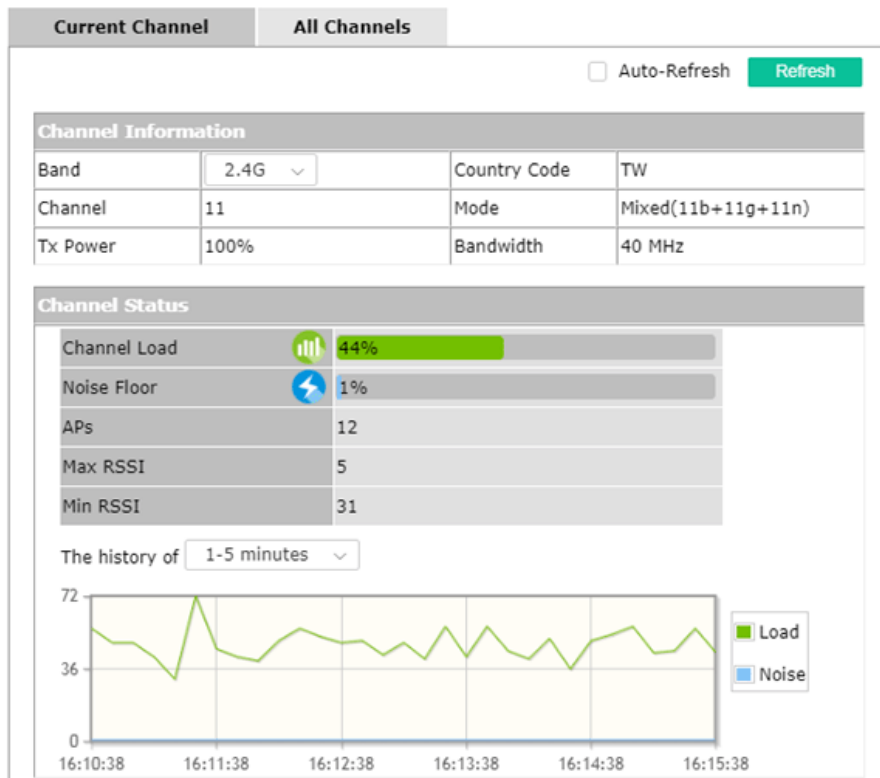

All Channels

This page displays the utilization and energy result for all channels based on 2.4G/5G. Click **Refresh** to get the newly update interference situation.

Diagnostics >> Interference Monitor

Current Channel | **All Channels**

Band: 2.4G Refresh

Recommended channel for usage: 2

Channel	Channel Utilization	Channel Energy	APs
1	34%	32%	3
2	11%	10%	0
3	15%	13%	0
4	30%	29%	0
5	32%	31%	1
6	47%	32%	16
7	34%	32%	1
8	23%	23%	0
9	29%	29%	0
10	31%	29%	0
11	63%	42%	20

Last updated: 12/13 14:47:20

Note: During the scanning process, no station is allowed to connect with the AP.

V-1-7 Support Area

When you click **Support Area**, you will be guided to visit www.draytek.com and open the corresponding pages directly.

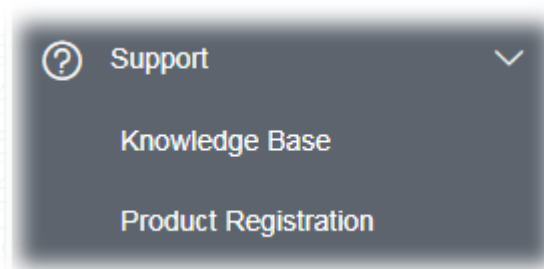

V-2 Checking the Hardware Status

Follow the steps below to verify the hardware status.

1. Check the power line and cable connections.
Refer to "**I-2 Hardware Installation**" for details.
2. Power on the modem. Make sure the **POWER LED**, **ACT LED** and **LAN LED** are bright.
3. If not, it means that there is something wrong with the hardware status. Simply back to "**I-2 Hardware Installation**" to execute the hardware installation again. And then, try again.

V-3 Checking the Network Connection Settings

Sometimes the link failure occurs due to the wrong network connection settings. After trying the above section, if the link is still failed, please do the steps listed below to make sure the network connection settings is OK.

V-3-1 For Windows

Note:

The example is based on Windows 7 (Professional Edition). As to the examples for other operation systems, please refer to the similar steps or find support notes in www.draytek.com.

1. Open **All Programs>>Getting Started>>Control Panel**. Click **Network and Sharing Center**.



2. In the following window, click **Change adapter settings**.

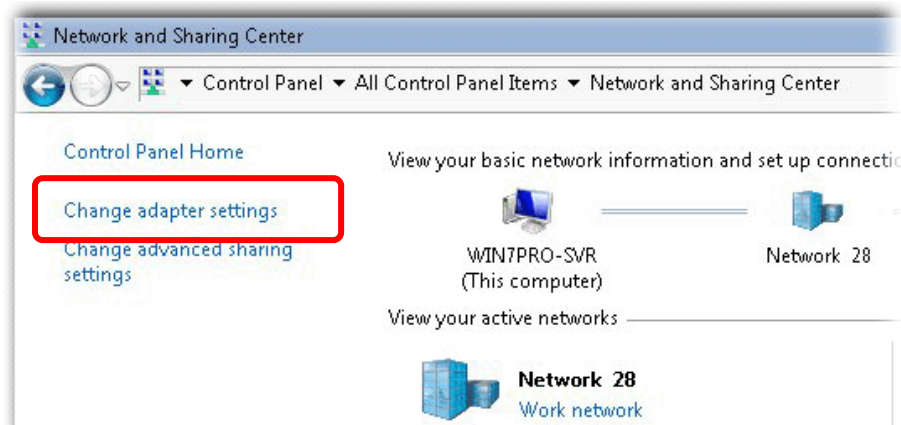

- Icons of network connection will be shown on the window. Right-click on **Local Area Connection** and click on **Properties**.

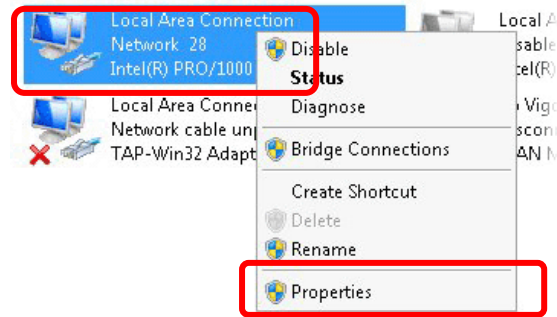

- Select **Internet Protocol Version 4 (TCP/IP)** and then click **Properties**.

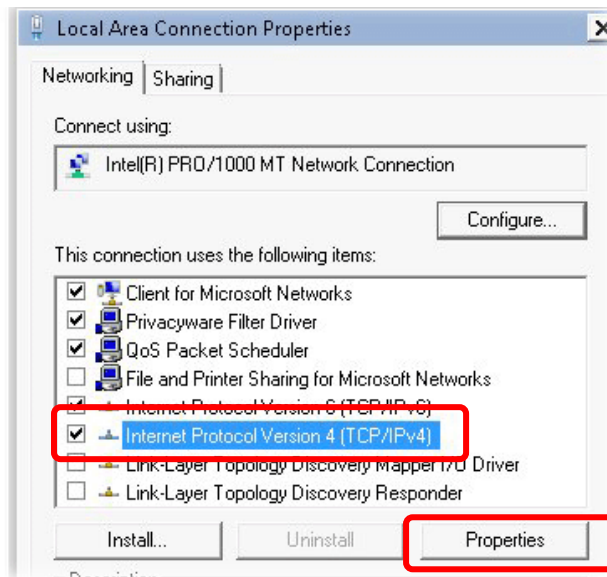

- Select **Obtain an IP address automatically** and **Obtain DNS server address automatically**. Finally, click **OK**.

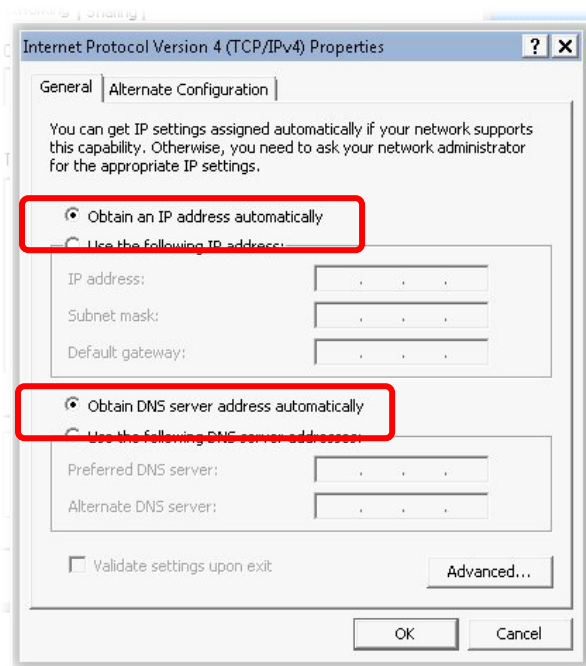

V-3-2 For Mac Os

1. Double click on the current used Mac Os on the desktop.
2. Open the **Application** folder and get into **Network**.
3. On the **Network** screen, select **Using DHCP** from the drop down list of Configure IPv4.

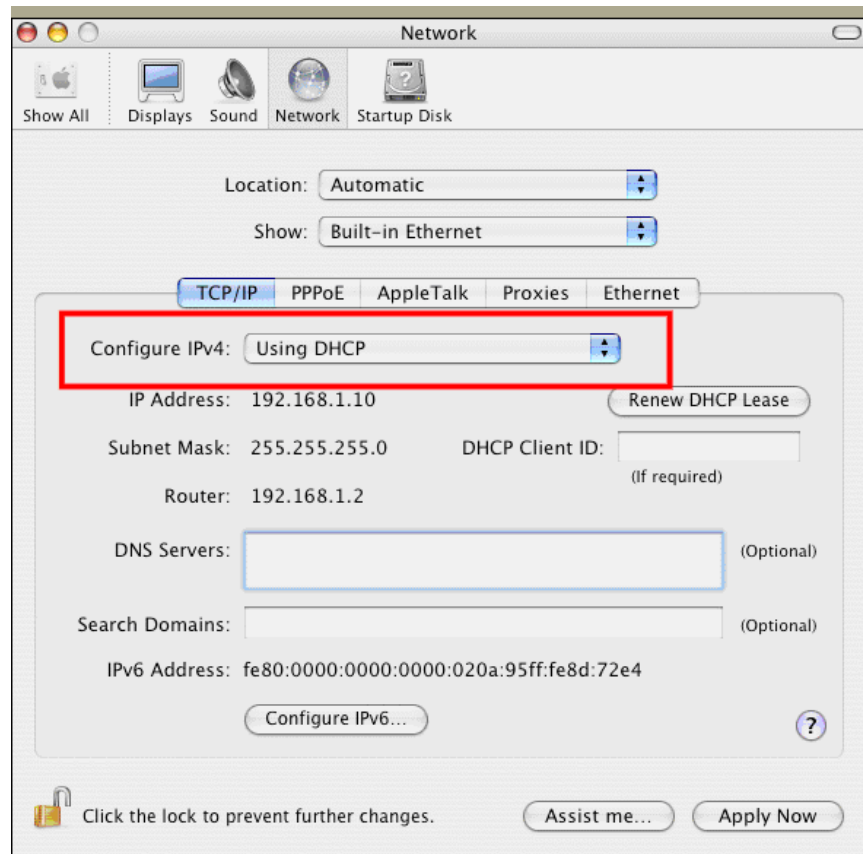

V-4 Pinging the Device

The default gateway IP address of the modem is 192.168.1.2. For some reason, you might need to use “ping” command to check the link status of the modem. **The most important thing is that the computer will receive a reply from 192.168.1.2.** If not, please check the IP address of your computer. We suggest you setting the network connection as **get IP automatically**. (Please refer to the section V-2)

Please follow the steps below to ping the modem correctly.

V-4-1 For Windows

1. Open the **Command Prompt** window (from **Start menu> Run**).
2. Type **command** (for Windows 95/98/ME) or **cmd** (for Windows NT/2000/XP/Vista/7). The DOS command dialog will appear.

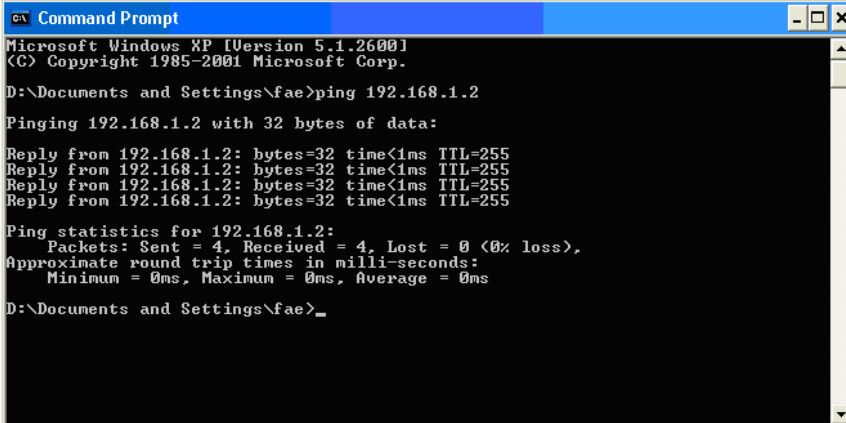

```
ex Command Prompt
Microsoft Windows XP [Version 5.1.2600]
(C) Copyright 1985-2001 Microsoft Corp.
D:\Documents and Settings\fae>ping 192.168.1.2
Pinging 192.168.1.2 with 32 bytes of data:
Reply from 192.168.1.2: bytes=32 time<1ms TTL=255
Reply from 192.168.1.2: bytes=32 time<1ms TTL=255
Reply from 192.168.1.2: bytes=32 time<1ms TTL=255
Reply from 192.168.1.2: bytes=32 time<1ms TTL=255

Ping statistics for 192.168.1.2:
    Packets: Sent = 4, Received = 4, Lost = 0 (0% loss),
    Approximate round trip times in milli-seconds:
        Minimum = 0ms, Maximum = 0ms, Average = 0ms
D:\Documents and Settings\fae>_
```

3. Type ping 192.168.1.2 and press [Enter]. If the link is OK, the line of “**Reply from 192.168.1.2:bytes=32 time<1ms TTL=255**” will appear.
4. If the line does not appear, please check the IP address setting of your computer.

V-4-2 For Mac Os (Terminal)

1. Double click on the current used Mac Os on the desktop.
2. Open the **Application** folder and get into **Utilities**.
3. Double click **Terminal**. The Terminal window will appear.
4. Type **ping 192.168.1.2** and press [Enter]. If the link is OK, the line of “**64 bytes from 192.168.1.2: icmp_seq=0 ttl=255 time=xxxx ms**” will appear.

```
Terminal — bash — 80x24
Last login: Sat Jan 3 02:24:18 on ttys1
Welcome to Darwin!
Vigor10:~ draytek$ ping 192.168.1.1
PING 192.168.1.1 (192.168.1.1): 56 data bytes
64 bytes from 192.168.1.1: icmp_seq=0 ttl=255 time=0.755 ms
64 bytes from 192.168.1.1: icmp_seq=1 ttl=255 time=0.697 ms
64 bytes from 192.168.1.1: icmp_seq=2 ttl=255 time=0.716 ms
64 bytes from 192.168.1.1: icmp_seq=3 ttl=255 time=0.731 ms
64 bytes from 192.168.1.1: icmp_seq=4 ttl=255 time=0.72 ms
^C
--- 192.168.1.1 ping statistics ---
5 packets transmitted, 5 packets received, 0% packet loss
round-trip min/avg/max = 0.697/0.723/0.755 ms
Vigor10:~ draytek$
```

V-5 Backing to Factory Default Setting

Sometimes, a wrong connection can be improved by returning to the default settings. Try to reset the modem by software or hardware.

Warning:

After pressing **factory default setting**, you will lose all settings you did before. Make sure you have recorded all useful settings before you pressing. The password of factory default is null.

V-5-1 Software Reset

You can reset the modem to factory default via Web page.

Go to **System Maintenance** and choose **Reboot System** on the web page. The following screen will appear. Choose **Using factory default configuration** and click **OK**. After few seconds, the modem will return all the settings to the factory settings.

System Maintenance >> Reboot System

Reboot System

Do You want to reboot your AP ?

- Using current configuration
- Using factory default configuration

OK

V-5-2 Hardware Reset

While the modem is running, press the **Factory Reset** button and hold for more than 5 seconds. When you see the **ACT** LED blinks rapidly, please release the button. Then, the modem will restart with the default configuration.

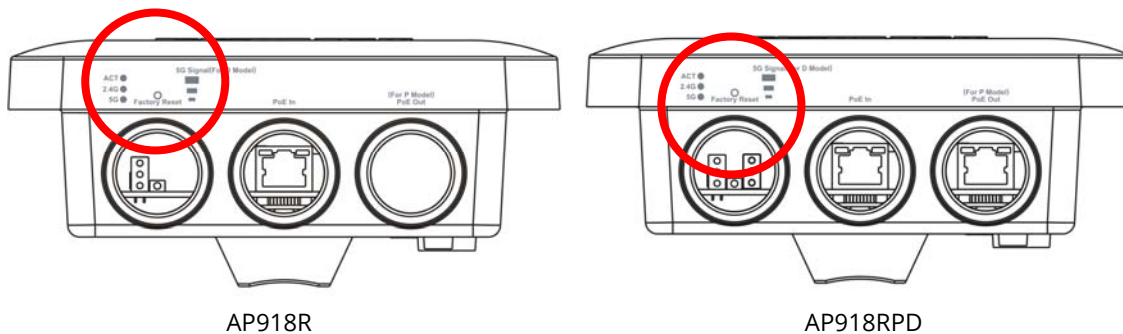

After restore the factory default setting, you can configure the settings for the modem again to fit your personal request.

V-6 Contacting DrayTek

If the modem still cannot work correctly after trying many efforts, please contact your dealer for further help right away. For any questions, please feel free to send e-mail to support@draytek.com.

Index

8

802.11n, 43

A

Access Control, 48

Action, 134

Advanced Setting, 50

AES, 32

Airtime Fairness, 55

Antenna, 51

AP Discovery, 53

AP Management, 1, 111

AP Mode, 41, 72, 85

AP Operation Mode, 21

APM Log, 112

Apple iOS Keep Alive, 134

Applications, 132, 140

Auth Mode, 49

Authentication Client, 129

Authentication Type, 129

Auto Adjustment, 55

Auto Channel Filtered Out List, 51

Auto Logout, 17

Auto Provision, 111

AutoSelect, 86

B

Band Steering, 61

Bandwidth Limit, 22, 25, 31

Bandwidth Management, 54

Black List, 113

C

Central AP Management, 111

Certificate Management, 129

Changing Password, 18

Channel, 43, 86

Channel Width, 50

Client IP, 129

Client PinCode, 50

Client's MAC Address, 113

Configuration Backup, 101, 102

Connection Time, 58

Connection Type, 87

Country Code, 51

D

Daylight Saving, 105

Default Gateway, 88

Detection, 115, 121, 122

DHCP Client, 89

DHCP server, 15

Download Limit, 55

E

EAP Type, 129

Encryp Type, 50

End Time, 133

Extension Channel, 43

F

Factory Default Setting, 174

Fast Roaming, 60

Firmware Upgrade, 110

Force Overload Disassociation, 113

Fragment Length, 51

G

General Setup, LAN, 89

H

Hardware Installation, 5

Hardware Reset, 175

Hide SSID, 43

HTTP port, 107

HTTPS, 131

HTTPS port, 107

I

Interference Monitor, 166
IP Address, 87, 89
Isolate Member, 43

K

Keep Alive Period, 99
Key Renewal Interval, 46
Key Size, 131
Key Type, 130

L

LAN, 89
LAN A, 3
LAN B, 3
Lease Time, 90
LED Indicators and Connectors, 3
Limit Client, 43
Limit Client per SSID, 43
Load Balance, 113

M

MAC Address, 86
MAC Address Filter, 48
MAC Clone, 52
Main SSID, 21, 24, 30
Management, 107
Management VLAN, 89
Mobile Device Management, 115
Mode, 43, 45

N

NTP, 132
NTP Client, 105
NTP Server, 105
NTP synchronization, 105

O

Once, 134
Open/Shared, 32, 87
Operation Mode, 36
Overload Management, 113

P

Pass Phrase, 46, 87
Password, 18
Password Strength, 100
Periodic Inform Settings, 99
PIN Code, 39
PMK Cache Period, 60
PoE Connection, 8
Policy, 48, 124, 125
Port, 47
Port Control, 92
Pre-Authentication, 60
Primary DNS Server, 90
PSK, 38
Push Button, 50

Q

Quick Start Wizard, 20

R

RADIUS Server, 46, 128
RADIUS Setting, 128
Reboot System, 109
Reconnection Time, 58
Relay Agent, 90
Restore, 49
Roaming, 59
Router Name, 87
Routine, 134
RSSI, 59
RTS Threshold, 51

S

Schedule, 132, 140, 142
Secondary DNS Server, 90
Secret Key, 129
Security, 45
Security Mode, 86
Security Overview, 38
Security Settings, 45
Session Timeout, 47
Shared Secret, 47
Show Chart, 122

Software Reset, 174
Speed Test, 162
SSL(HTTPS), 99
Start Date, 133
Start PBC, 39
Start Time, 133
Station Control, 22, 25, 31, 57
Station List, 66
Status of Settings, 114
STUN, 99
Subject Name, 130
Subnet, 43
Subnet Mask, 88, 89
Support Area, 167
Syslog/Mail Alert, 104
System Log, 162
System Maintenance, 96
System Status, 97

T

Temperature Sensor, 136, 137
Temperature Sensor Graph, 138
Time and Date, 105
Time Zone, 105
TKIP, 32, 38
Total Download Limit, 55
Total Upload Limit, 55
TR-069, 98

Traffic Graph, 163
traffic overload, 113
Triggering Client Number, 56
Trust DHCP Server, 90
Tx Power, 51

U

Upload Limit, 55
Users Profile, 129

V

VLAN ID, 43, 89

W

WEP, 32
WEP (Wired Equivalent Privacy), 38
White List, 113
Wi-Fi DOWN, 134
Wi-Fi UP, 134
Wired Connection, 5, 6
Wireless Connection, 7
Wireless LAN (2.4GHz/5GHz), 38
WLAN (2.4GHz) Statistics, 164
WLAN (5GHz) Statistics, 165
WPA (Wi-Fi Protected Access), 38
WPA Algorithms, 46
WPS, 49
WPS (Wi-Fi Protected Setup), 38