

Vigor2927 Series Dual-WAN Security Router Quick Start Guide (for RF Model)

Version: 1.82

Firmware Version: V4.4.3.1

(For future update, please visit [DrayTek web site](http://www.draytek.com))

Date: November 01, 2023

Intellectual Property Rights (IPR) Information

Copyrights	© All rights reserved. This publication contains information that is protected by copyright. No part may be reproduced, transmitted, transcribed, stored in a retrieval system, or translated into any language without written permission from the copyright holders.
Trademarks	The following trademarks are used in this document: <ul style="list-style-type: none">● Microsoft is a registered trademark of Microsoft Corp.● Windows, 8, 10, 11 and Explorer are trademarks of Microsoft Corp.● Apple and Mac OS are registered trademarks of Apple Inc.● Other products may be trademarks or registered trademarks of their respective manufacturers.

Safety Instructions and Approval

Safety Instructions	<ul style="list-style-type: none">● Read the installation guide thoroughly before you set up the router.● The router is a complicated electronic unit that may be repaired only by authorized and qualified personnel. Do not try to open or repair the router yourself.● Do not place the router in a damp or humid place, e.g. a bathroom.● Do not stack the routers.● The router should be used in a sheltered area, within a temperature range of +5 to +40 Celsius.● Do not expose the router to direct sunlight or other heat sources. The housing and electronic components may be damaged by direct sunlight or heat sources.● Do not deploy the cable for LAN connection outdoor to prevent electronic shock hazards.● Do not power off the router when saving configurations or firmware upgrades. It may damage the data in a flash. Please disconnect the Internet connection on the router before powering it off when a TR069/ACS server manages the router.● Keep the package out of reach of children.● When you want to dispose of the router, please follow local regulations on conservation of the environment.
Warranty	We warrant to the original end user (purchaser) that the router will be free from any defects in workmanship or materials for a period of two (2) years from the date of purchase from the dealer. Please keep your purchase receipt in a safe place as it serves as proof of date of purchase. During the warranty period, and upon proof of purchase, should the product have indications of failure due to faulty workmanship and/or materials, we will, at our discretion, repair or replace the defective products or components, without charge for either parts or labor, to whatever extent we deem necessary to restore the product to proper operating condition. Any replacement will consist of a new or re-manufactured functionally equivalent product of equal value, and will be offered solely at our discretion. This warranty will not apply if the product is modified, misused, tampered with, damaged by an act of God, or subjected to abnormal working conditions. The warranty does not cover the bundled or licensed software of other vendors. Defects which do not significantly affect the usability of the product will not be covered by the warranty. We reserve the right to revise the manual and online documentation and to make changes from time to time in the contents hereof without obligation to notify any person of such revision or changes.



Declaration of Conformity

Hereby, DrayTek Corporation declares that the equipment type Vigor2927 is in compliance with Radio Equipment Directive 2014/53/EU, Low Voltage Directive 2014/35/EU and RoHS 2011/65/EU.

The full text of the EU Declaration of Conformity is available at the following internet address:
<https://fw.draytek.com.tw/Vigor2927/Document/CE/>

Manufacturer: DrayTek Corp.

Address: No. 26, Fushing Rd., HuKou, Hsinchu Industrial Park, Hsinchu 303, Taiwan

Product: Vigor2927 Wireless Series

Frequency Information for Europe area:

2.4GHz WLAN	For ac series, 2400MHz - 2483MHz, max. TX power: 19.78dBm *1
	For ax series, 2400MHz - 2483MHz, max. TX power: 19.86dBm *1
5GHz WLAN	For ac series, 5150MHz - 5350MHz, max. TX power: 22.84dBm *2 5470MHz - 5725MHz, max. TX power: 27.88dBm *2
	For ax series, 5150MHz - 5350MHz, max. TX power: 22.79dBm *2 5470MHz - 5725MHz, max. TX power: 29.78dBm *2
LTE	B1[1920-1980 MHz (TX); 2110-2170 MHz (RX)]; B3[1710-1785 MHz (TX); 1805-1880 MHz (RX)]; B7[2500-2570 MHz (TX); 2620-2690 MHz (RX)]; B8[880-915 MHz (TX); 925-960 MHz (RX)]; B20[832-862 MHz (TX); 791-821 MHz (RX)]; B28[703-748 MHz (TX); 758-803 MHz (RX)]; B38[2570-2620 MHz (TX); 2570-2620 MHz (RX)]; B40[2300-2400 MHz (TX); 2300-2400 MHz (RX)]*3
3G	B1[1920-1980 MHz (TX); 2110-2170 MHz (RX)]; B8[880-915 MHz (TX); 925-960 MHz (RX)] *3
	Requirements in AT/BE/BG/CZ/ DK/EE/FR/DE/IS/IE/IT/EL/ES/ CY/LV/LI/LT/LU/HU/MT/NL/NO/PL/PT/RO/SI/SK/TR/FI/SE/CH/HR/ UK(NI). 5150MHz-5350MHz is for indoor use only.

(*1: for 2.4GHz WLAN model; *2: for 5GHz WLAN model; *3: for LTE model)

This product is designed for LTE and 2.4GHz /5GHz WLAN network throughout the EC region.



Declaration of Conformity

Hereby, DrayTek Corporation declares that the equipment type Vigor2927 is in compliance with the Radio Equipment Regulations 2017 (SI 2017 No.1206, The Electrical Equipment (Safety) Regulations 2016 (SI 2016 No.1101), and The Restriction of the Use of Certain Hazardous Substances in Electrical and Electronic Equipment Regulations 2012 (SI 2012 No. 3032).

The full text of the UKCA Declaration of Conformity is available at the following internet address:
<https://fw.draytek.com.tw/Vigor2927/Document/CE/>

Manufacturer: DrayTek Corp.

Address: No. 26, Fushing Rd., Hukou, Hsinchu Industrial Park, Hsinchu 303, Taiwan

Product: Vigor2927 Wireless Series

Frequency Information for UK area:

2.4GHz WLAN	For ac series, 2400MHz - 2483MHz, max. TX power: 19.78dBm *1
	For ax series, 2400MHz - 2483MHz, max. TX power: 19.86dBm *1
5GHz WLAN	For ac series, 5150MHz - 5350MHz, max. TX power: 22.84dBm *2 5470MHz - 5725MHz, max. TX power: 27.88dBm *2
	For ax series, 5150MHz - 5350MHz, max. TX power: 22.79dBm *2 5470MHz - 5725MHz, max. TX power: 29.78dBm *2
LTE	B1[1920-1980 MHz (TX); 2110-2170 MHz (RX)]; B3[1710-1785 MHz (TX); 1805-1880 MHz (RX)]; B7[2500-2570 MHz (TX); 2620-2690 MHz (RX)]; B8[880-915 MHz (TX); 925-960 MHz (RX)]; B20[832-862 MHz (TX); 791-821 MHz (RX)]; B28[703-748 MHz (TX); 758-803 MHz (RX)]; B38[2570-2620 MHz (TX); 2570-2620 MHz (RX)]; B40[2300-2400 MHz (TX); 2300-2400 MHz (RX)]*3
3G	B1[1920-1980 MHz (TX); 2110-2170 MHz (RX)]; B8[880-915 MHz (TX); 925-960 MHz (RX)] *3
	Requirements in UK. 5150MHz-5350MHz is for indoor use only.

(*1: for 2.4GHz WLAN model; *2: for 5GHz WLAN model; *3: for LTE model)

This product is designed for LTE and 2.4GHz /5GHz WLAN network use in the UK & Ireland.

*The external power supply used for each product will be model dependent.

	1	2	3	4	5	6	7	8	9
A Manufacturer	CWT	CWT	CWT	CWT	CWT	APD	APD	APD	APD
B Address	No. 222, Sec. 2, Nankan Rd., Lujhu Township, Taoyuan County 338, Taiwan	No. 222, Sec. 2, Nankan Rd., Lujhu Township, Taoyuan County 338, Taiwan	No. 222, Sec. 2, Nankan Rd., Lujhu Township, Taoyuan County 338, Taiwan	No. 222, Sec. 2, Nankan Rd., Lujhu Township, Taoyuan County 338, Taiwan	No. 222, Sec. 2, Nankan Rd., Lujhu Township, Taoyuan County 338, Taiwan	No. 5, Lane 83, Lung-Sou St., Taoyuan City 330, Taiwan	No. 5, Lane 83, Lung-Sou St., Taoyuan City 330, Taiwan	No. 5, Lane 83, Lung-Sou St., Taoyuan City 330, Taiwan	No. 5, Lane 83, Lung-Sou St., Taoyuan City 330, Taiwan
C Model identifier	2ABB012F UK 2ABB012F EU	2ABB018F UK 2ABB018F EU	2ABL024F UK 2ABL024F EU	2ABL030F UK 2ABL030F EU	2ABN036F UK 2ABN036F EU	WA-12M12FG WA-12M12FK	WB-18D12FG WB-18D12FK	WA-24Q12FG WA-24Q12FK	WA-36A12FG WA-36A12FK
D Input voltage	100-240V	100-240V	100-240V	100-240V	100-240V	100-240V	100-240V	100-240V	100-240V
E Input AC frequency	50/60Hz	50/60Hz	50/60Hz	50/60Hz	50/60Hz	50/60Hz	50/60Hz	50/60Hz	50/60Hz
Output voltage DC	12.0V	12.0V	12.0V	12.0V	12.0V	12.0V	12.0V	12.0V	12.0V
F Output current	1.0A	1.5A	2.0A	2.5A	3.0A	1.0A	1.5A	2.0A	3.0A
G Output power	12.0W	18.0W	24.0W	30.0W	36.0W	12.0W	18.0W	24.0W	36.0W
H Average active efficiency	84.9%	86.2%	87.6%	87.8%	89.8%	83.7%	85.4%	88.6%	88.2%
I Efficiency at low load 10%	73.6%	78.0%	81.3%	83.3%	83.7%	74.5%	80.5%	86.4%	85.4%
J No-load power consumption	0.07W	0.07W	0.07W	0.07W	0.07W	0.07W	0.10W	0.07W	0.10W

External power supply (Power Adapter) information. For more update, please visit www.draytek.com.





Regulatory Information

Federal Communication Commission Interference Statement

This equipment has been tested and found to comply with the limits for a Class B digital device, pursuant to Part 15 of the FCC Rules. These limits are designed to provide reasonable protection against harmful interference in a residential installation. This equipment generates, uses and can radiate radio frequency energy and, if not installed and used in accordance with the instructions, may cause harmful interference to radio communications. However, there is no guarantee that interference will not occur in a particular installation. If this equipment does cause harmful interference to radio or television reception, which can be determined by turning the equipment off and on, the user is encouraged to try to correct the interference by one of the following measures:

- Reorient or relocate the receiving antenna.
- Increase the separation between the equipment and receiver.
- Connect the equipment into an outlet on a circuit different from that to which the receiver is connected.
- Consult the dealer or an experienced radio/TV technician for help.

This device complies with Part 15 of the FCC Rules. Operation is subject to the following two conditions:

- (1) This device may not cause harmful interference, and
- (2) This device may accept any interference received, including interference that may cause undesired operation.

USA Local Representative	Company name	ABP International Inc.		
	Address	13988 Diplomat Drive Suite 180 Dallas TX 75234		
	ZIP Code	75234	E-mail	itadmin@abptech.com
	Contact Person	Mr. Henry N Castillo	Tel.	(972)831-1600 140

Caution:

Any changes or modifications not expressly approved by the grantee of this device could void the user's authority to operate the equipment.

This transmitter must not be co-located or operating in conjunction with any other antenna or transmitter.

Radiation Exposure Statement: This equipment complies with FCC radiation exposure limits set forth for an uncontrolled environment. This equipment should be installed and operated with minimum distance 20cm between the radiator & your body.

The antenna/transmitter should be kept at least 20 cm away from human body.

Table of Contents

1. Package Content	1
2. Panel Explanation.....	2
2.1 Vigor2927L	2
2.2 Vigor2927ac / Vigor2927ax / Vigor2927Lac	4
2.3 Vigor2927Vac	8
3. Hardware Installation	11
3.1 Network Connection	11
3.2 Wall-Mounted Installation	12
3.3 Antenna Installation (for “L” model).....	13
Warning	14
4. Software Configuration	15
5. Customer Service	22
Be a Registered Owner	22
Firmware & Tools Updates	22

1. Package Content

Take a look at the package content. If there is anything missed or damaged, please contact DrayTek or the dealer immediately. Besides, the content is subject to the real package.



Vigor Router

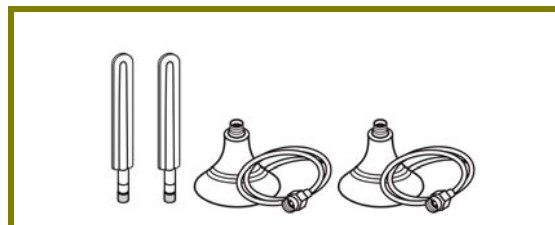

2 sets (Antenna + Extension Base)

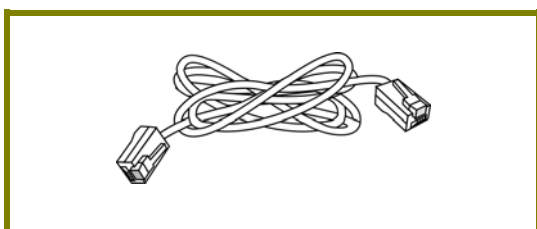

RJ-45 Cable (Ethernet)



Antenna (for ac / ax models)

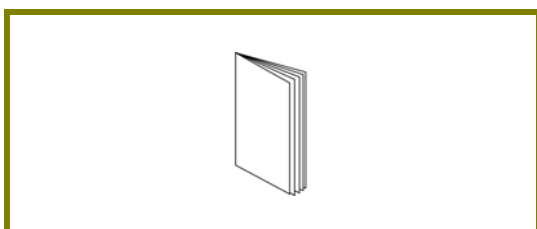

Quick Start Guide

The type of the power adapter depends on the country that the router will be installed. * The maximum power consumption is **28 Watt**.

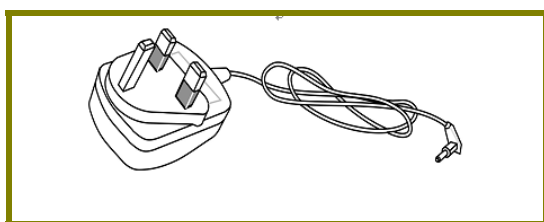

UK-type Power Adapter

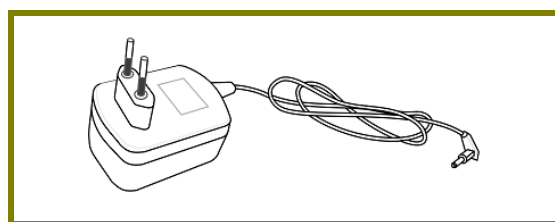

EU-type Power Adapter

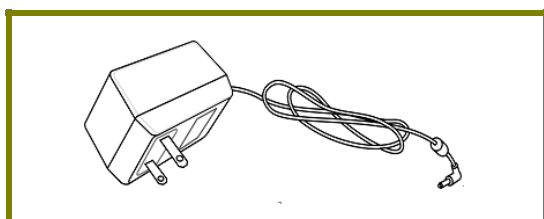

USA/Taiwan-type Power Adapter

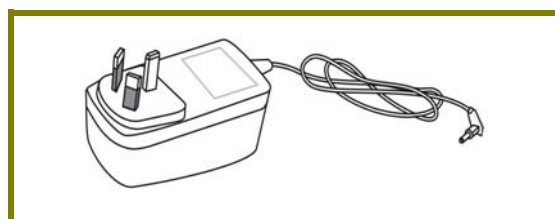

AU/NZ-type Power Adapter

2. Panel Explanation

2.1 Vigor2927L

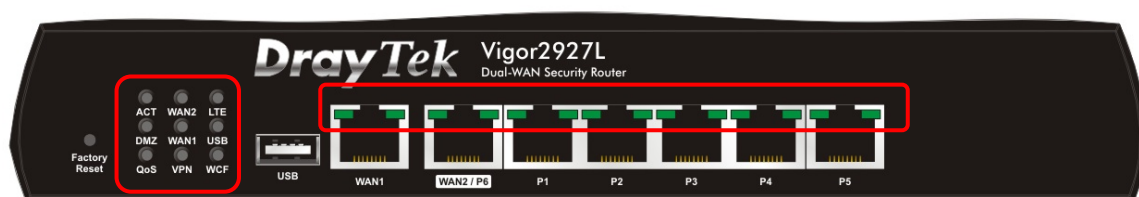

LED	Status	Explanation
ACT	Off	The router is powered off.
	Blinking	The router is powered on and running normally.
WAN2/WAN1	On	Internet connection is ready.
	Off	Internet connection is not ready.
	Blinking	The data is transmitting.
LTE	On	LTE device is connected and ready for use.
	Off	LTE device is not detected, or has serious problem (e.g., no SIM card, SIM pin error, SIM deactivated, and etc.).
	Blinking	Slowly: LTE device is in dialing up. Quickly: The data is transmitting.
DMZ	On	The DMZ function is enabled.
	Off	The DMZ function is disabled.
	Blinking	The data is transmitting.
USB	On	USB device is connected and ready for use.
	Off	No USB device is connected.
	Blinking	The data is transmitting.
QoS	On	The QoS function is active.
	Off	The QoS function is inactive.
VPN	On	The VPN tunnel is active.
	Off	VPN services are disabled
	Blinking	Traffic is passing through VPN tunnel.
WCF	On	The Web Content Filter is active. (It is enabled from Firewall >> General Setup).
	Off	WCF is disabled.
WAN1, WAN2 / P6		
Left LED	On	The port is connected.
	Off	The port is disconnected.
	Blinking	The data is transmitting.
Right LED	On	The port is connected with 1000Mbps.
	Off	The port is connected with 10/100Mbps.

LAN P1-P5		
Left LED	On	The port is connected.
	Off	The port is disconnected.
	Blinking	The data is transmitting.
Right LED	On	The port is connected with 1000Mbps.
	Off	The port is connected with 10/100Mbps

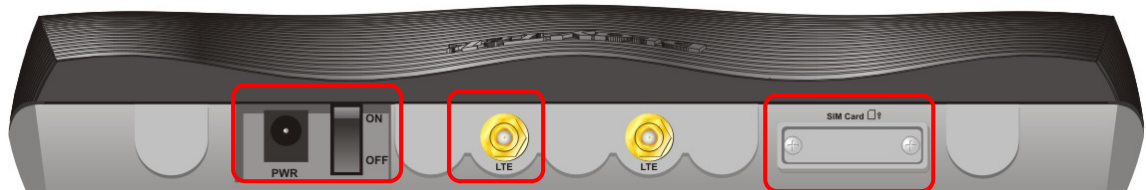
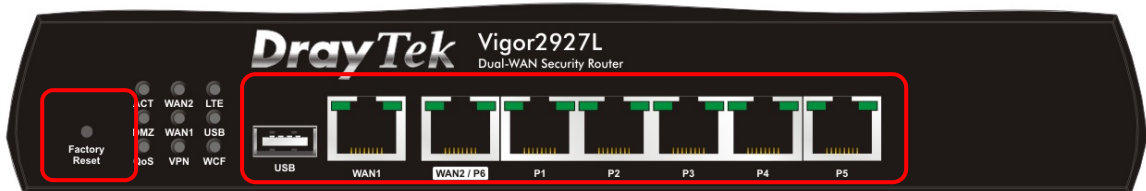

Interface	Description
Factory Reset	Restore the default settings. Usage: Turn on the router (ACT LED is blinking). Press the hole and keep for more than 5 seconds. When you see the ACT LED begins to blink rapidly than usual, release the button. Then the router will restart with the factory default configuration.
USB	Connector for a USB device (for 3G/4G USB Modem or printer or thermometer).
WAN1	Connector for local network devices or modem for accessing Internet.
WAN2 / P6	Connector for local network devices or modem for accessing Internet. It is a switchable port. It can be used for LAN connection or WAN connection according to the settings configured in WUI.
LAN P1-P5	Connectors for local network devices.
PWR	Connector for a power adapter.
ON/OFF	Power Switch.
	Connector for installing LTE antennas.
SIM Card	Slots for installing SIM card(s).

2.2 Vigor2927ac / Vigor2927ax / Vigor2927Lac

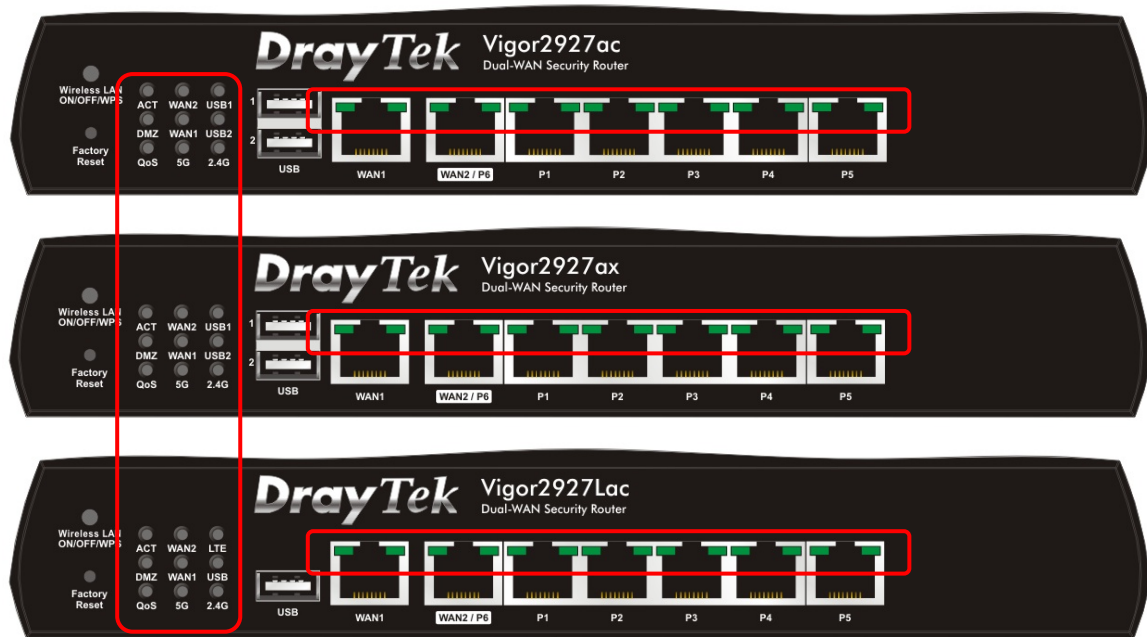

LED	Status	Explanation
ACT	Off	The router is powered off.
	Blinking	The router is powered on and running normally.
WAN2/WAN1	On	Internet connection is ready.
	Off	Internet connection is not ready.
	Blinking	The data is transmitting.
USB1/USB2	On	USB device is connected and ready for use.
	Off	No USB device is connected.
	Blinking	The data is transmitting.
LTE	On	LTE device is connected and ready for use.
	Off	LTE device is not detected, or has serious problem (e.g., no SIM card, SIM pin error, SIM deactivated, and etc.).
	Blinking	Slowly: LTE device is in dialing up. Quickly: The data is transmitting.
DMZ	On	The DMZ function is enabled.
	Off	The DMZ function is disabled.
	Blinking	The data is transmitting.
QoS	On	The QoS function is active.
	Off	The QoS function is inactive.
5G / 2.4G	On	5G / 2.4G: Wireless access point with bandwidth of 5GHz/2.4GHz is ready. WLAN: Wireless access point is ready.

	Off	Wireless function is disabled.
	Blinking	It will blink slowly while wireless traffic goes through. ACT and WLAN LEDs blink quickly and simultaneously when WPS is working, and will return to normal condition after two minutes. (You need to setup WPS within 2 minutes.)

WAN1,WAN2 / P6



Left LED	On	The port is connected.
	Off	The port is disconnected.
	Blinking	The data is transmitting.
Right LED	On	The port is connected with 1000Mbps.
	Off	The port is connected with 10/100Mbps.

LAN P1-P5

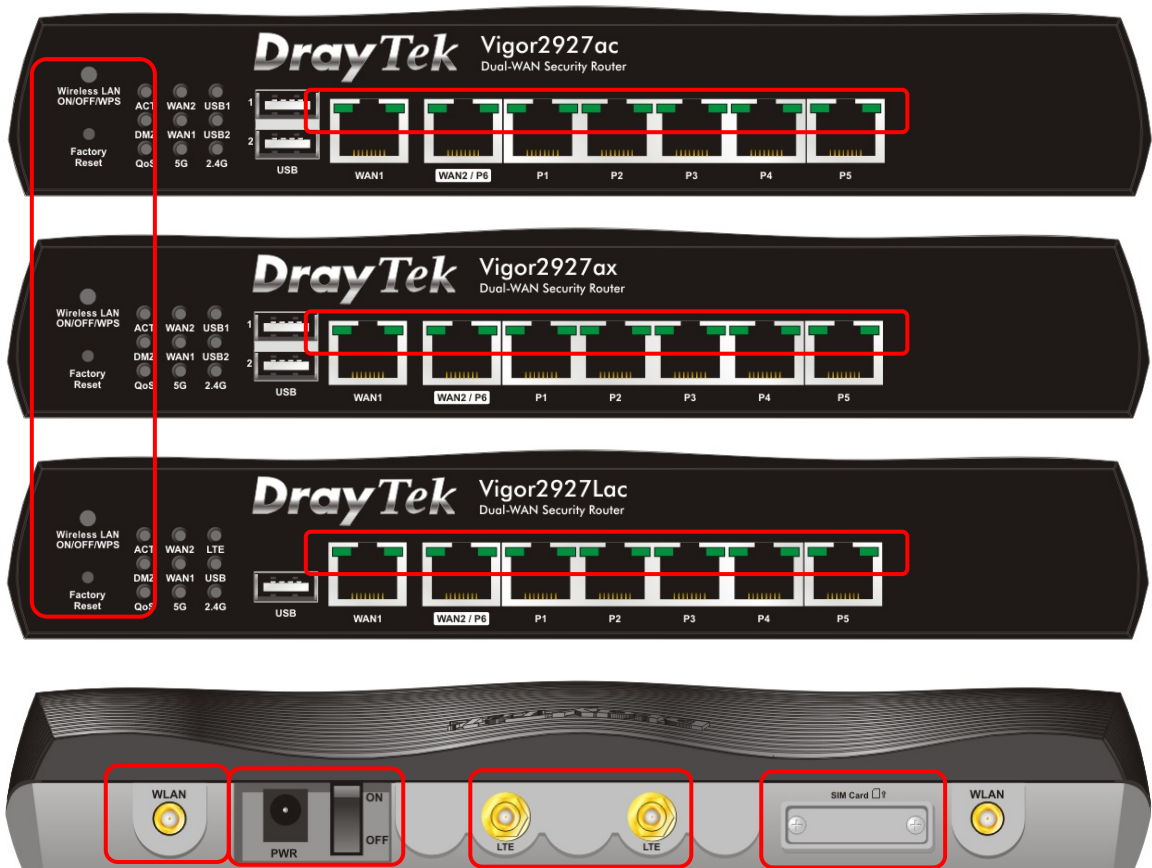
Left LED	On	The port is connected.
	Off	The port is disconnected.
	Blinking	The data is transmitting.
Right LED	On	The port is connected with 1000Mbps.
	Off	The port is connected with 10/100Mbps



Interface	Description
Wireless LAN ON/OFF/WPS	<p>Wireless band will be switched /changed according to the button pressed and released. For example,</p> <ul style="list-style-type: none"> ● 2.4G (On) and 5G (On) - in default. ● 2.4G (Off) and 5G (On) - pressed and released the button once. ● 2.4G (On) and 5G (Off) - pressed and released the button twice. ● 2.4G (Off) and 5G (Off) - pressed and released the button three times. <p>When WPS function is enabled by web user interface, press this button for more than 2 seconds to wait for client's device making network connection through WPS.</p>
Factory Reset	<p>Restore the default settings. Usage: Turn on the router (ACT LED is blinking). Press the hole and keep for more than 5 seconds. When you see the ACT LED begins to blink rapidly than usual, release the button. Then the router will restart with the factory default configuration.</p>
USB1~2 / USB	<p>Connector for a USB device (for 3G/4G USB Modem or printer or thermometer).</p>
WAN1	<p>Connector for local network devices or modem for accessing Internet.</p>

WAN2 / P6	<p>Connector for local network devices or modem for accessing Internet.</p> <p>It is a switchable port. It can be used for LAN connection or WAN connection according to the settings configured in WUI.</p>
LAN P1-P5	Connectors for local network devices.
	<p>Connector for installing WLAN antennas.</p> <p>(For WiFi model)</p>
PWR	Connector for a power adapter.
ON/OFF	Power Switch.
	<p>Connector for installing LTE antennas.</p> <p>(For L model).</p>
SIM Card	<p>Slots for installing SIM card(s).</p> <p>(For L model).</p>

2.3 Vigor2927Vac

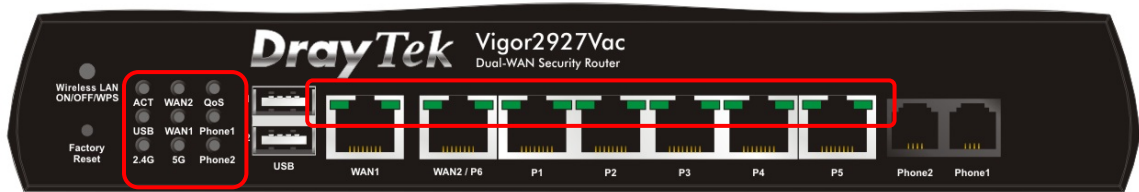

LED	Status	Explanation
ACT	Off	The router is powered off.
	Blinking	The router is powered on and running normally.
WAN2/WAN1	On	Internet connection is ready.
	Off	Internet connection is not ready.
	Blinking	The data is transmitting.
QoS	On	The QoS function is active.
	Off	The QoS function is inactive.
USB	On	USB device is connected and ready for use.
	Off	No USB device is connected.
	Blinking	The data is transmitting.
Phone1/ Phone2	On	The phone connected to this port is off-hook.
	Off	The phone connected to this port is on-hook.
	Blinking	A phone call comes.
2.4G/5G	On	5G / 2.4G: Wireless access point with bandwidth of 5GHz/2.4GHz is ready. WLAN: Wireless access point is ready.
	Off	Wireless function is disabled.
	Blinking	It will blink slowly while wireless traffic goes through. ACT and WLAN LEDs blink quickly and simultaneously when WPS is working, and will return to normal condition after two minutes. (You need to setup WPS within 2 minutes.)
WAN1, WAN2 / P6		
Left LED	On	The port is connected.
	Off	The port is disconnected.
	Blinking	The data is transmitting.
Right LED	On	The port is connected with 1000Mbps.
	Off	The port is connected with 10/100Mbps.

LAN P1-P5		
Left LED	On	The port is connected.
	Off	The port is disconnected.
	Blinking	The data is transmitting.
Right LED	On	The port is connected with 1000Mbps.
	Off	The port is connected with 10/100Mbps



Interface	Description
Wireless LAN ON/OFF/WPS	<p>Wireless band will be switched /changed according to the button pressed and released. For example,</p> <ul style="list-style-type: none"> ● 2.4G (On) and 5G (On) - in default. ● 2.4G (Off) and 5G (On) - pressed and released the button once. ● 2.4G (On) and 5G (Off) - pressed and released the button twice. ● 2.4G (Off) and 5G (Off) - pressed and released the button three times. <p>When WPS function is enabled by web user interface, press this button for more than 2 seconds to wait for client's device making network connection through WPS.</p>
Factory Reset	<p>Restore the default settings. Usage: Turn on the router (ACT LED is blinking). Press the hole and keep for more than 5 seconds. When you see the ACT LED begins to blink rapidly than usual, release the button. Then the router will restart with the factory default configuration.</p>
USB1~2 / USB	<p>Connector for a USB device (for 3G/4G USB Modem or printer or thermometer).</p>
WAN1	<p>Connector for local network devices or modem for accessing Internet.</p>
WAN2 / P6	<p>Connector for local network devices or modem for accessing Internet. It is a switchable port. It can be used for LAN connection or WAN connection according to the settings configured in WUI.</p>

LAN P1-P5	Connecters for local network devices.
	Connector for installing WLAN antennas. (For WiFi model)
PWR	Connector for a power adapter.
ON/OFF	Power Switch.

3. Hardware Installation

This section will guide you to install the router through hardware connection and configure the router's settings through web browser.

Before starting to configure the router, you have to connect your devices correctly. (For the hardware connection, we take “ac” model as an example.)

3.1 Network Connection

1. Connect the cable Modem/DSL Modem/Media Converter to any WAN port of router with Ethernet cable (RJ-45).
2. Connect one end of an Ethernet cable (RJ-45) to one of the LAN ports of the router and the other end of the cable (RJ-45) into the Ethernet port on your computer.
3. Connect one end of the power adapter to the router's power port on the rear panel, and the other side into a wall outlet.
4. Power on the device by pressing down the power switch on the rear panel.
5. The system starts to initiate. After completing the system test, the ACT LED will light up and start blinking. (For the detailed information of LED status, please refer to section 2. Panel Explanation)

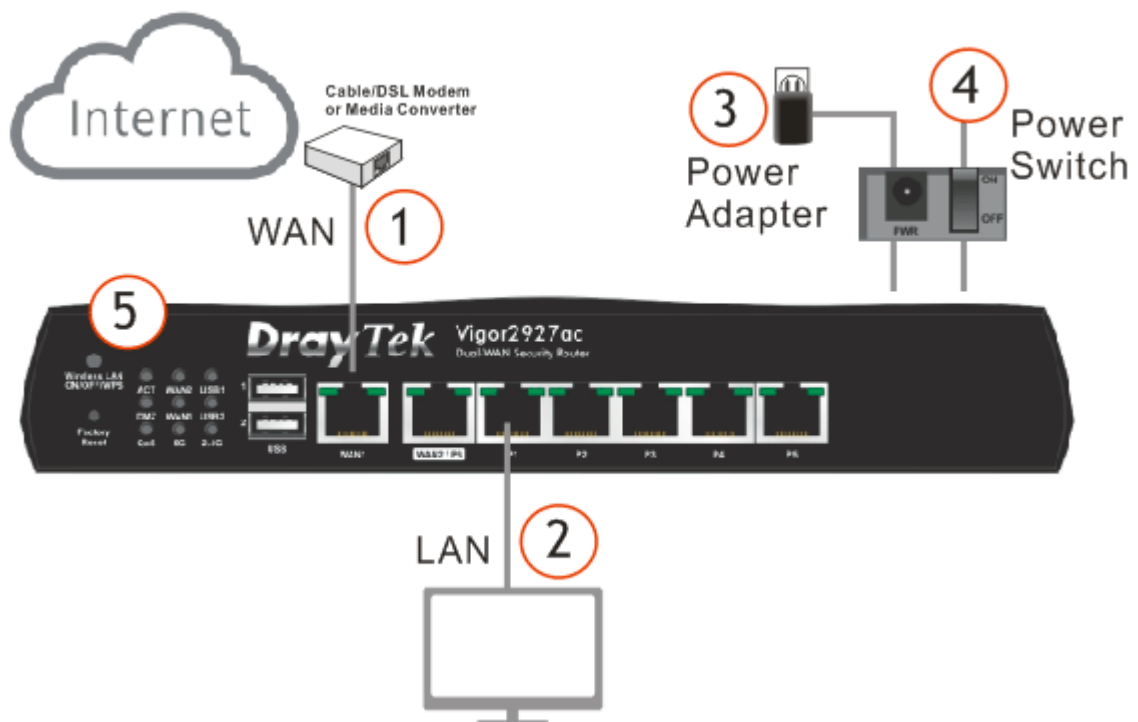

3.2 Wall-Mounted Installation

Vigor router has keyhole type mounting slots on the underside.

1. Drill two holes on the wall. The distance between the holes shall be 168mm.
2. Fit screws into the wall using the appropriate type of wall plug.

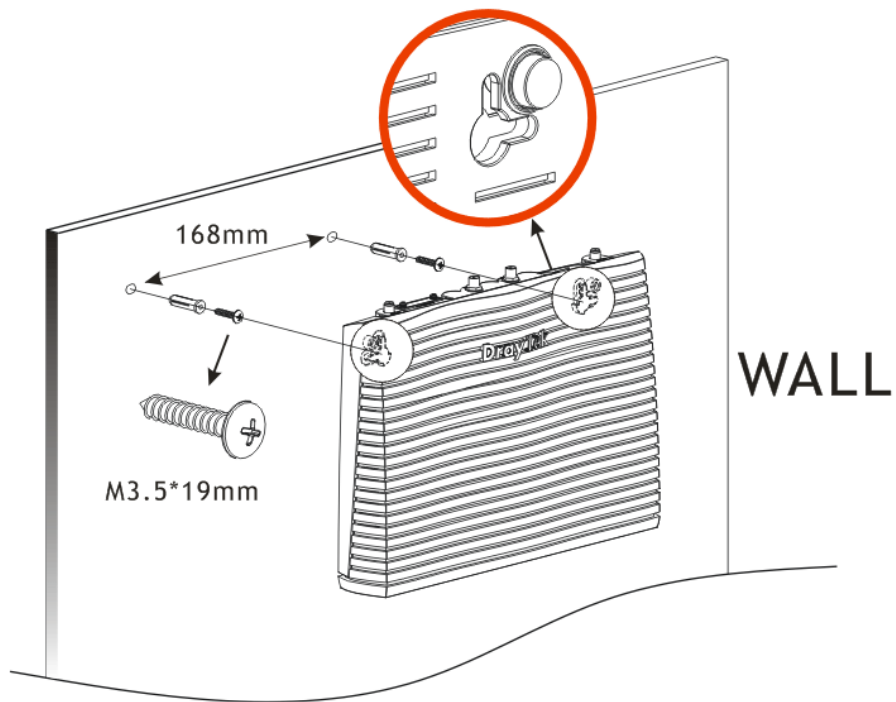

Note

The recommended drill diameter shall be 6.5mm (1/4").

3. When you finished about procedure, the router has been mounted on the wall firmly.

3.3 Antenna Installation (for “L” model)

Magnetic antenna must be installed on the extension base before connecting to Vigor router.

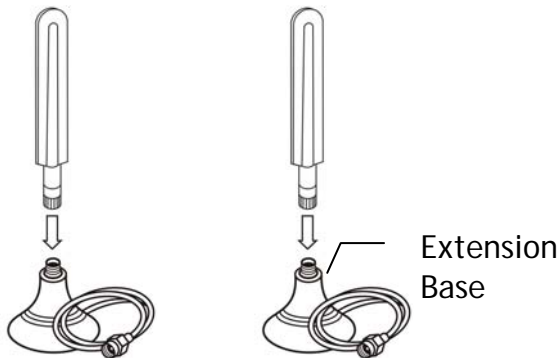

The antenna with an extension base on the Vigor router must be installed correctly. If only one antenna shall be installed, please use the connector (main signal connector) near the power switch.



For installing the SIM card into the card slot, here, we take Vigor2927Lac as an example.

- (1) Assemble the extension base with the antenna.
- (2) While installing the SIM card into the card slot, note that the back plate of the SIM card slot must be removed first.
- (3) Assemble the SIM1 and SIM2 with the card cassette. Later insert the cassette into the SIM card slot and the direction of card notch must be on the left side.

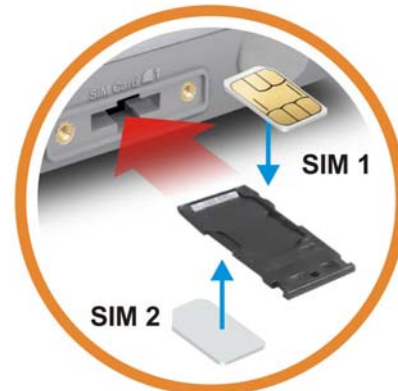

Warning

There are two types of antennas provided for Vigor2927Lac, which must be installed in different locations carefully and correctly. Wrong installation might cause bad signal of wireless connection. Therefore, pay attention to the installation of antennas by referring to the following illustration.

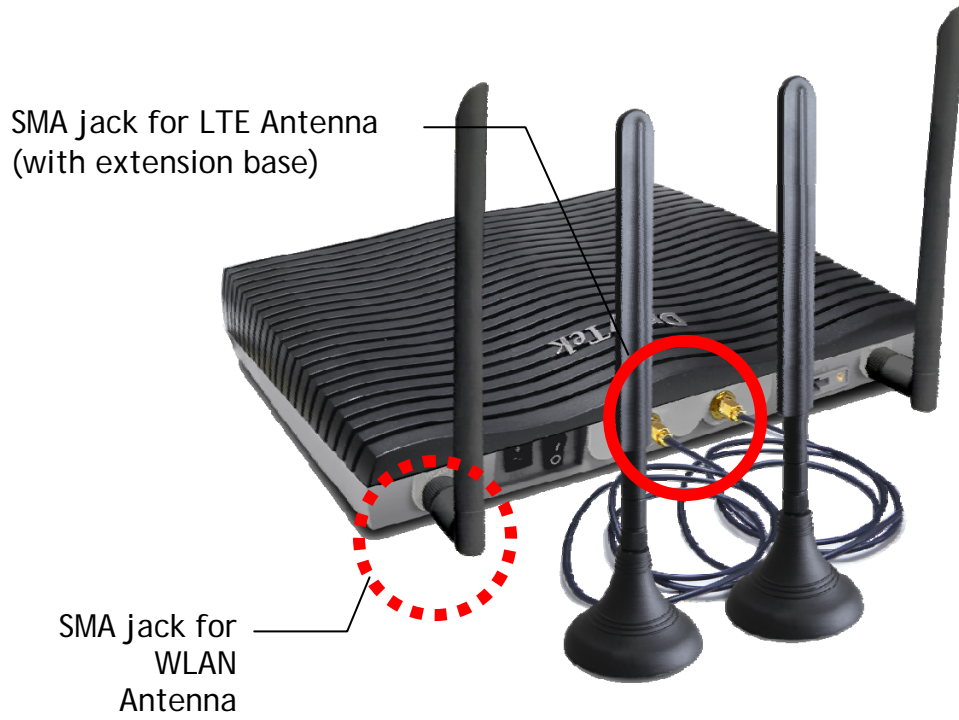

4. Software Configuration

To access Internet, please finish basic configuration after completing the hardware installation.

The **Quick Start Wizard** is designed for you to easily set up your router for Internet access. You can directly access the **Quick Start Wizard** via Web User Interface. Make sure your PC connects to the router correctly.



Note

You may either simply set up your computer to get IP dynamically from the router or set up the IP address of the computer to be the same subnet as the default IP address of Vigor router 192.168.1.1. For the detailed information, please refer to - Trouble Shooting of the user's guide.

Open a web browser on your PC and type **http://192.168.1.1**. A pop-up window will open to ask for username and password. Please enter "admin/admin" as the Username/Password and click **Login**.

DrayTek **Vigor2927 Series**

Login

Username

Password

Login

Security Warning: You are logging in without encryption which is not recommended. To login securely [click here](#).

Copyright © 2000-2019 DrayTek Corp. All Rights Reserved.



Note

If you fail to access to the web configuration, please go to "Trouble Shooting" on User's Guide for detecting and solving your problem.

Now, the Main Screen will pop up. Click **Wizards>>Quick Start Wizard**.



Note The home page will change slightly in accordance with the router you have. Here we take Vigor2927Vac as an example.

If your router can be under an environment with high speed NAT, the configuration provide here can help you to deploy and use the router quickly. The first screen of **Quick Start Wizard** is entering login password. After typing the password, please click **Next**.

Quick Start Wizard

Enter login password

Please enter an alpha-numeric string as your **Password** (Max 83 characters)

Old Password

New Password

Confirm Password

Password Strength: Weak Medium Strong

Strong password requirements:

1. Have at least one upper-case letter and one lower-case letter.
2. Including non-alphanumeric characters is a plus.

Hint: If you want to keep the password unchanged, leave the password blank and press "Next" button to skip this process.

On the next page as shown below, please select the WAN interface that you use. If Ethernet interface is used, please choose WAN1 or WAN2; if wireless 2.4G/5G connection is used, please choose WAN3 or WAN4; if 3G USB modem/LTE module is used, please choose WAN5/LTE or WAN6. Then click Next for next step. Each WAN interface will bring up specific configuration page.

Wizards >> Quick Start Wizard

Select WAN Interface

Select WAN Interface:	<input type="text" value="WAN1"/>
Display Name:	<input type="text"/>
Physical Mode:	Ethernet
Physical Type:	<input type="text" value="Auto negotiation"/>
VLAN Tag insertion:	<input type="text" value="Disable"/>
Tag value	<input type="text"/> (0~4095)
Priority	<input type="text"/> (0~7)

Click Next. You have to select the appropriate Internet access type (PPPoE, PPTP, L2TP, Static IP or DHCP) according to the information from your ISP.

Here we take PPPoE and DHCP modes for WAN connection as examples.

For PPPoE Connection

1. Choose WAN1 as WAN Interface and click the Next button; you will get the following page.

Quick Start Wizard

Connect to Internet

WAN 1
Select one of the following Internet Access types provided by your ISP.

PPPoE
 PPTP
 L2TP
 Static IP
 DHCP

< Back Next > Finish Cancel

2. Select PPPoE and click Next to get the following page.

Quick Start Wizard

PPPoE Client Mode

WAN 1
Enter the user name and password provided by your ISP.

Service Name (Optional)	CHT
Username	84005657@hinet.net
Password	*****
Confirm Password	*****

< Back Next > Finish Cancel

3. Enter the Username/Password provided by your ISP. Then click **Next** for viewing the summary of such connection.

Wizards >> Quick Start Wizard

Please confirm your settings:

WAN Interface:	WAN1
Physical Mode:	Ethernet
Physical Type:	Auto negotiation
Internet Access:	PPPoE

Click **Back** to modify changes if necessary. Otherwise, click **Finish** to save the current settings and restart the Vigor router.

4. Click **Finish**. A page of **Quick Start Wizard Setup OK!!!** will appear. Then, the system status of this protocol will be shown.
5. Now, you can enjoy surfing on the Internet.

For DHCP Connection

1. Choose WAN1 as WAN Interface and click the Next button; you will get the following page.

Quick Start Wizard

Connect to Internet

WAN 1
Select one of the following Internet Access types provided by your ISP.

PPPoE
 PPTP
 L2TP
 Static IP
 DHCP

< Back Next > Finish Cancel

2. Select DHCP and click Next to get the following page.

Quick Start Wizard

DHCP Client Mode

WAN 1
If your ISP requires you to enter a specific host name or specific MAC address, please enter it in.

Host Name (optional)
MAC (optional)

< Back Next > Finish Cancel

3. Enter the hostname and / or MAC address provided by your ISP. Then click **Next** for viewing summary of such connection.

Wizards >> Quick Start Wizard

Please confirm your settings:

WAN Interface:	WAN1
Physical Mode:	Ethernet
Physical Type:	Auto negotiation
Internet Access:	DHCP

Click **Back** to modify changes if necessary. Otherwise, click **Finish** to save the current settings and restart the Vigor router.

< Back

Next >

Finish

Cancel

4. Click **Finish**. A page of **Quick Start Wizard Setup OK!!!** will appear. Then, the system status of this protocol will be shown.

Quick Start Wizard Setup OK!

5. Now, you can enjoy surfing on the Internet.

5. Customer Service

If the router cannot work correctly after trying many efforts, please contact your dealer for further help right away. For any questions, please feel free to send e-mail to support@draytek.com.

Be a Registered Owner

Web registration is preferred. You can register your Vigor router via <https://myvigor.draytek.com>.

Firmware & Tools Updates

Due to the continuous evolution of DrayTek technology, all routers will be regularly upgraded. Please consult the DrayTek web site for more information on newest firmware, tools and documents.

<https://www.draytek.com>

ALVACO
Telecomunicaciones
Espana, S.L
*Avenida de Italia 10 Centro
de Transportes de Coslada
28821 Coslada, Madrid,
Spain*

AntiPode
*12 Rue des Chauffours
95000 Cergy - France*

BRINET sp. z o.o. sp.k.
*ul. Lubowska 23, 60-433
Poznań*

CMS
*UK - CMS Distribution
Limited, 15 Worship Street,
London, EC2A 2DT
Ireland - CMS Distribution
Limited, Bohola Road,
Kiltimagh, Co Mayo, Ireland*

Comdate Access AB
*Industrivagen 44, 941 47
Pitea Sweden*

IKI d.o.o. ZAGREB
*IKI d.o.o, Rapska 42,
10000 Zagreb, Croatia*

LEXIS S.A.
*2-4, Karpathou str. &
Ethnikis Antistaseos,
15344, Gerakas,
Athens-Greece*

Network Elements Kft.
*1095 Budapest Mester
37-39, B lh. alagsor 4.,
Hungary*

NoWire Nordic AB
*Box 8167, 163 08 Spanga,
Sweden*

OptiVisus Lda.
*Rua Capitão Ramires
nº17A
1000-084 Lisboa,
Portugal*

ScanAccess A/S
*Kirkeltevej 138, 3450
Allerod, DK, DENMARK*

Spider Electronics sas
*Via Enrico Fermi
11-10040, Caselette (TO)
Italy.*

Telos d.o.o.
*Parmova 14, 1000
Ljubljana, Slovenia*

UniVorex GmbH
*Zeppelinstrasse 3, 12529,
Schoenefeld, Germany*

Xpert Data b.v.
*Oosterveldsingel 2
7558 PK Hengelo (Ov)*