

Vigor2763 Series VDSL2 Security Router Quick Start Guide

(Wireless models)

Guide Version: 1.3

For updates and support, visit www.draytek.com

May 2024 / Firmware V4.4.3.2

Note: Product specification is subject to continuous evolution which may not always be reflected in current documentation. For the formal specification and details of the supported features of your product, please refer to the web site at www.draytek.com

Safety and Warranty Information

Safety Instructions	<ul style="list-style-type: none"> ● Read the installation guide thoroughly before you set up the router. ● The router is a complicated electronic unit that may be repaired only by authorized and qualified personnel. Do not try to open or repair the router yourself. ● Do not place the router in a damp or humid place, e.g. a bathroom. ● Do not stack the routers. ● The router should be used in a sheltered area, within a temperature range of 0 to +40 Celsius. ● Do not expose the router to direct sunlight or other heat sources. The housing and electronic components may be damaged by direct sunlight or heat sources. ● Do not deploy the cable for LAN connection outdoor to prevent electronic shock hazards. ● Do not power off the router when saving configurations or firmware upgrades. It may damage the data in a flash. Please disconnect the Internet connection on the router before powering it off when a TR-069/ ACS server manages the router. ● Keep the package out of reach of children. ● When you want to dispose of the router, please follow local regulations on conservation of the environment.
Warranty	<p>We warrant to the original end user (purchaser) that the router will be free from any defects in workmanship or materials for a period of two (2) years from the date of purchase from a DrayTek authorized dealer in the UK/Ireland. Please keep your purchase receipt in a safe place as it serves as proof of date of purchase. During the warranty period, and upon proof of purchase, should the product have indications of failure due to faulty workmanship and/or materials, we will, at our discretion, repair or replace the defective products or components, without charge for either parts or labour, to whatever extent we deem necessary to restore the product to proper operating condition. Any replacement will consist of a new or re-manufactured functionally equivalent product of equal value, and will be offered solely at our discretion. This warranty will not apply if the product is modified, misused, tampered with, damaged by external factors, used with unapproved accessories or subjected to abnormal working conditions. Warranty applies to hardware only, not software or firmware. Defects which do not significantly affect the usability of the product will not be covered by the warranty. We reserve the right to revise the manual and online documentation and to make changes from time to time in the contents hereof without obligation to notify any person of such revision or changes.</p>
Importer	<p>UK - CMS Distribution Limited, 15 Worship Street, London, EC2A 2DT Ireland - CMS Distribution Limited, Bohola Road, Kiltimagh, Co Mayo, Ireland</p>

External Power Supply (Power Adapter) Information

	1	2	3	4	5	6	7	8	9	10	11	12	
A	Manufacturer	CWT	CWT	CWT	CWT	CWT	APD	APD	APD	APD	MOSO	MOSO	MOSO
B	Address	No. 222, Sec. 2, Nankan Rd., Lujhu Township, Taoyuan County 338, Taiwan	No. 222, Sec. 2, Nankan Rd., Lujhu Township, Taoyuan County 338, Taiwan	No. 222, Sec. 2, Nankan Rd., Lujhu Township, Taoyuan County 338, Taiwan	No. 222, Sec. 2, Nankan Rd., Lujhu Township, Taoyuan County 338, Taiwan	No. 222, Sec. 2, Nankan Rd., Lujhu Township, Taoyuan County 338, Taiwan	No.5, Lane 83, Lung-Sou St., Taoyuan City 330, Taiwan	No.5, Lane 83, Lung-Sou St., Taoyuan City 330, Taiwan	No.5, Lane 83, Lung-Sou St., Taoyuan City 330, Taiwan	No. 5, Lane 83, Lung-Sou St., Taoyuan City 330, Taiwan	Sangtai Industrial Park, Guanwai Xiaobaimang Songbai Road, Nanshan District, 518108 Shenzhen Guangdong, China	Sangtai Industrial Park, Guanwai Xiaobaimang Songbai Road, Nanshan District, 518108 Shenzhen Guangdong, China	Sangtai Industrial Park, Guanwai Xiaobaimang Songbai Road, Nanshan District, 518108 Shenzhen, Guangdong, China
C	Model identifier	2ABB012F UK	2ABB018F UK	2ABL024F UK	2ABL030F UK	2ABN036F UK	WA-12M1 2FG	WB-18D1 2FG	WA-24Q1 2FG	WA-36A1 2FG	MS-V2000R12 0-024Q0-GB	MS-V2500WR 120-030E0-GB	V30-V3000R 12 0-036T0-GB
		2ABB012F EU	2ABB018F EU	2ABL024F EU	2ABL030F EU	2ABN036F EU	WA-12M1 2FK	WB-18D1 2FK	WA-24Q1 2FK	WA-36A1 2FK	MS-V2000R12 0-024Q0-DE	MS-V2500WR 120-030E0-DE	V30-V3000R 12 0-036T0-DE
D	Input voltage	100-240V	100-240V	100-240V	100-240V	100-240V	100-240V	100-240V	100-240V	100-240V	100-240V	100-240V	100-240V
E	Input AC frequency	50/60Hz	50/60Hz	50/60Hz	50/60Hz	50/60Hz	50/60Hz	50/60Hz	50/60Hz	50/60Hz	50/60Hz	50/60Hz	50/60Hz
	Output voltage DC	12.0V	12.0V	12.0V	12.0V	12.0V	12.0V	12.0V	12.0V	12.0V	12.0V	12.0V	12.0V
F	Output current	1.0A	1.5A	2.0A	2.5A	3.0A	1.0A	1.5A	2.0A	3.0A	2.0A	2.5A	3.0A
G	Output power	12.0W	18.0W	24.0W	30.0W	36.0W	12.0W	18.0W	24.0W	36.0W	24.0W	30.0W	36.0W
H	Average active efficiency	84.9%	86.2%	87.6%	87.8%	89.8%	83.7%	85.4%	88.6%	88.2%	87.8%	89.5%	89.3%
I	Efficiency at low load 10%	73.6%	78.0%	81.3%	83.3%	83.7%	74.5%	80.5%	86.4%	85.4%	85.4%	84.7%	87.7%
J	No-load power consumption	0.07W	0.07W	0.07W	0.07W	0.07W	0.07W	0.10W	0.07W	0.10W	0.10W	0.08W	0.10W

For more updates & information, please visit www.draytek.com. The external power supply used for each product will be model dependent.



Join the UK mailing list



Users in the UK & Ireland can sign up to our mailing list which goes out approximately 4 times per year with products news, updates, hints & tips and offers. For details, please visit www.draytek.co.uk/list

Firmware & Tools Updates

Due to the continuous evolution of DrayTek technology and emerging risks, router firmware updates may be issued. Please consult the DrayTek web site for more information on newest firmware, tools and documents:
www.draytek.co.uk (For UK/Ireland)
www.draytek.com (For other countries)



Declaration of Conformity

Hereby, DrayTek Corporation declares that the equipment type Vigor2763 is in compliance with the Radio Equipment Directive 2014/53/EU, Low Voltage Directive 2014/35/EU and RoHS 2011/65/EU.

The full text of the EU declaration of conformity is available at the following internet address:

<https://fw.draytek.com.tw/Vigor2763/Document/CE/>

Manufacturer: DrayTek Corp.

Address: No. 26, Fushing Rd., Hukou, Hsinchu Industrial Park, Hsinchu 303, Taiwan

Product: Vigor2763 Wireless Series

Frequency Information for Europe area:

2.4GHz WLAN	2400MHz - 2483 MHz, max. TX power: 19.79dBm	*1
5GHz WLAN	5150MHz - 5350 MHz, max. TX power: 22.74dBm 5470MHz - 5725 MHz, max. TX power: 29.88dBm	*2
	Requirements in AT/BE/BG/CZ/DK/EE/FR/DE/IS/IE/IT/EL/ES/CY/LV/LI/LT/LU/HU/MT/NL/NO/PL/PT/RO/SI/SK/TR/FI/SE/CH/HR/UK(NI). 5150MHz-5350MHz is for indoor use only.	

(*1: for 2.4GHz WLAN model; *2: for 5GHz WLAN model)

This product is designed for DSL and 2.4GHz / 5GHz WLAN network throughout the EC region.



Declaration of Conformity

Hereby, DrayTek Corporation declares that the equipment type Vigor2763 is in compliance with the Radio Equipment Regulations 2017 (SI 2017 No.1206, The Electrical Equipment (Safety) Regulations 2016 (SI 2016 No.1101), and The Restriction of the Use of Certain Hazardous Substances in Electrical and Electronic Equipment Regulations 2012 (SI 2012 No. 3032).

The full text of the UKCA Declaration of Conformity is available at the following internet address:

<https://fw.draytek.com.tw/Vigor2763/Document/CE/>

Manufacturer: DrayTek Corp.

Address: No. 26, Fushing Rd., Hukou, Hsinchu Industrial Park, Hsinchu 303, Taiwan

Product: Vigor2763 Wireless Series

Frequency Information for UK area:

2.4GHz WLAN	2400MHz - 2483 MHz, max. TX power: 19.79dBm	*1
5GHz WLAN	5150MHz - 5350 MHz, max. TX power: 22.74dBm 5470MHz - 5725 MHz, max. TX power: 29.88dBm	*2



Requirements in UK. 5150MHz~5350MHz is for indoor use only.

(*1: for 2.4GHz WLAN model; *2: for 5GHz WLAN model)

This product is designed for DSL and 2.4GHz /5GHz WLAN network use in the UK & Ireland.



UK PSTI STATEMENT OF COMPLIANCE

We, DrayTek Corp., office at No.26, Fushing Rd., Hukou, Hsinchu Industrial Park, Hsinchu 303, Taiwan, declare under our sole responsibility that the product

The full text of the PSTI Declaration of Conformity is available at the following internet address: <https://fw.draytek.com.tw/UK/PSTI/>

- Product name: VDSL2 Security Router
- Model number: Vigor2763, Vigor2763ac
- Manufacturer: DrayTek Corp.
- Address: No.26, Fushing Rd., Hukou, Hsinchu Industrial Park, Hsinchu 303, Taiwan

is in conformity with the relevant UK Statutory Instruments: The Product Security and Telecommunications Infrastructure (Security Requirements for Relevant Connectable Products) Regulations 2023 (“Security Requirements”).

Standard	Version
The Product Security and Telecommunications Infrastructure Regulations	2023 Schedule 1
Support Period	3 years after the EOL notification

Please note that this statement of compliance, including the Defined Support Period stated herein, is only applicable to products sold in the UK.

This Statement of Compliance is retained by DrayTek for 10 years after date of issue.

Hsinchu
(place)

27th Mar., 2024
(date)



Alan Wen
General Manager Office. VP
 (Legal Signature)

Table of Contents

1. Package Contents	1
2. Panel Explanation	2
2.1 Vigor2763ac	2
3. Hardware Installation	4
3.1 Connecting up the Vigor Router	4
3.2 Wall-Mounting the Vigor Router	5
4. Setup & Configuration	6
4.1 Accessing the Router Web Interface.....	6
4.2 WAN1 – ADSL & VDSL Connection Setup	9
4.2.1 PPPoE connection with FTTC VDSL2	9
4.2.2 DHCP / Static IP connection with FTTC VDSL2	12
4.2.3 PPPoA connection with ADSL / ADSL2+.....	15
5. Getting Further Help	17
5.1 Additional Feature Setup	17
5.2 Keep up to date with our mailing list	17
5.3 Firmware Updates	17

1. Package Contents



DrayTek Vigor router

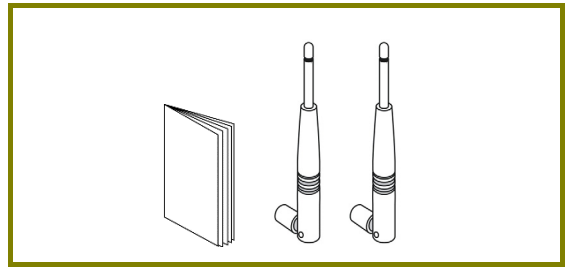

Quick Start Guide and Antenna
(This document)

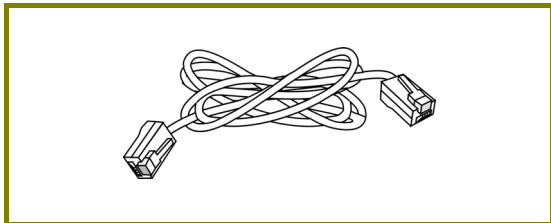

RJ-45 Cable (Ethernet)
(Connects to your PC or Switch)

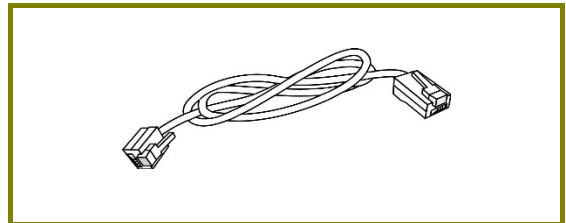

RJ-11 to RJ-11 Cable
(Connects to your DSL line)

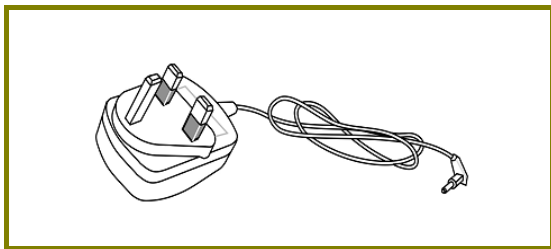

UK Power Adapter

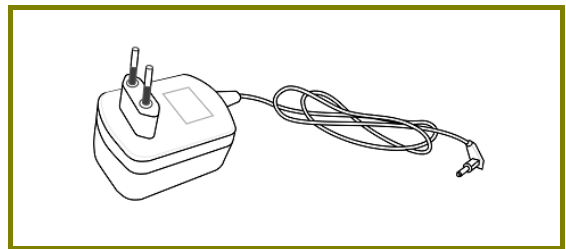

EU-type Power Adapter

The maximum power consumption is **17-23 Watts**.







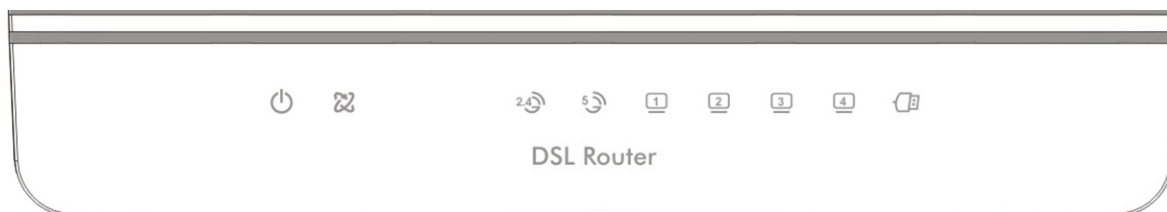

**Important
Note**

Remove the protective film from the router before use to ensure ventilation.

2. Panel Explanation

2.1 Vigor2763ac



LED	Status	Explanation
 (Activity)	Blinking	The router is ready and operating normally
	Off	The router is powered off
 (DSL)	On	DSL connection synchronised
	Blinking (Slowly)	DSL connection not currently synchronizing or not detected
	Blinking (Quickly)	DSL connection is synchronising
 (Wireless LAN On/Off/WPS)	On (Green)	2.4GHz Access Point is active
	Blinking (Green)	Data is being transmitted on the router's 2.4 GHz wireless interface
	Blinking (Orange)	WPS pairing mode is active for two minutes
	Off	2.4GHz Access Point is turned off
 (Wireless LAN On/Off/WPS)	On (Green)	5GHz Access Point is active
	Blinking (Green)	Data is being transmitted on the router's 5GHz wireless interface
	Blinking (Orange)	WPS pairing mode is active for two minutes
 (LAN1/2/3/4)	On	Ethernet LAN (RJ45) is connected
	Blinking	Data is transmitting (sending/receiving)
	Off	Ethernet LAN is disconnected
 (USB)	On	USB device is connected and ready for use
	Blinking	Data is being transmitted over USB

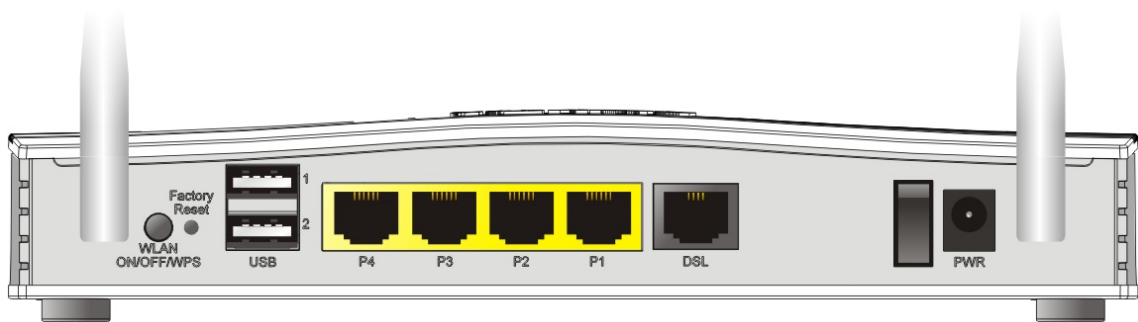

Interface	Description
WLAN ON/OFF/WPS	<p>Press for less than 2 seconds to switch toggle the router's wireless interfaces:</p> <p>For example,</p> <ul style="list-style-type: none"> ● 2.4G (On) and 5G (On) - Default state. ● 2.4G (Off) and 5G (On) - press and release the button once. ● 2.4G (On) and 5G (Off) - press and release the button twice. ● 2.4G (Off) and 5G (Off) - press and release the button three times. <p>When WPS is enabled in the router's web interface, press this button for more than 2 seconds to enable WPS pairing mode.</p>
Factory Reset	<p>Restore the default settings.</p> <p>Usage: Turn on the router (ACT LED is blinking). Press gently and hold for more than 5 seconds. When the ACT LED blinks rapidly, release the button. Then the router will restart with the factory default configuration</p>
USB1~USB2	Connector for a USB 3G/4G modem, storage, printer or USB Thermometer
P1~P4	RJ-45 Gigabit Ethernet connectors for local network devices.
DSL	RJ-11 connector for ADSL or VDSL line
I/O	Power Switch. Turns the unit on (I) or off (O)
PWR	Connector for the power adapter

3. Hardware Installation

This section will guide you to install the router through hardware connection and configure the router's settings through web browser.

3.1 Connecting up the Vigor Router

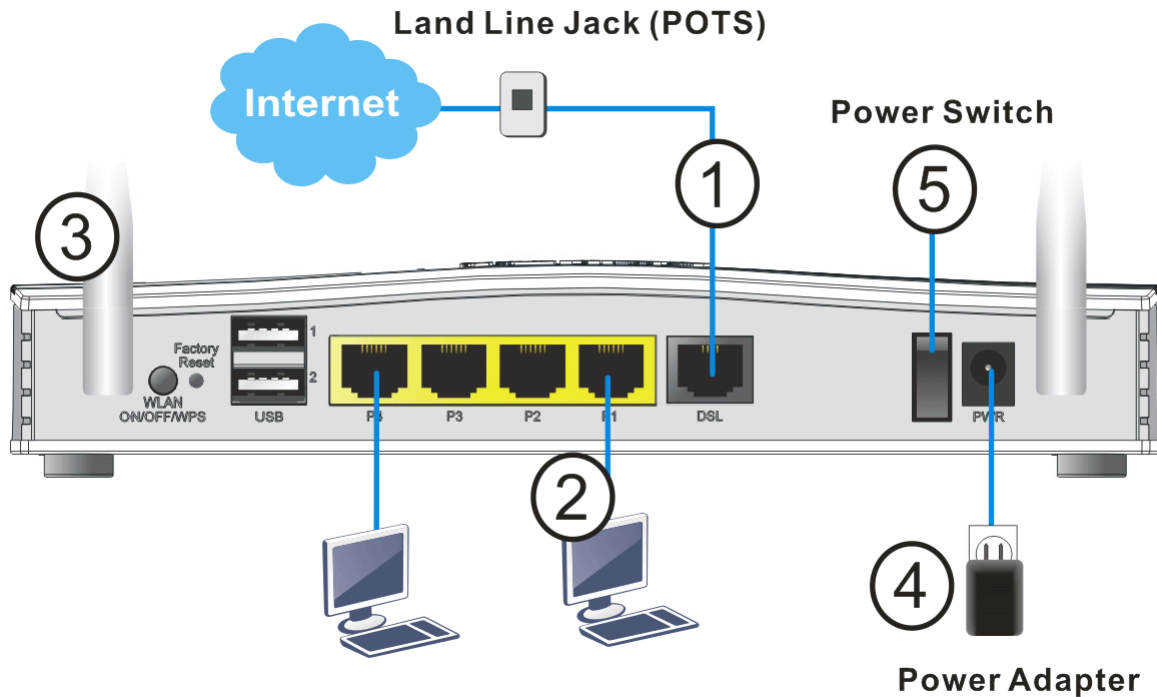

1. **ADSL/VDSL Connections:** Connect the **DSL** port to the **Modem** or **DSL** port of the external splitter/microfilter (not supplied) with the RJ-11 line cable. In some cases, your RJ-11 DSL socket will be built-into your phone line socket on the wall and you won't have a separate microfilter/splitter.
2. **LAN Connections:** Connect a LAN port of the router to your computer or switch.
3. **Wireless Antennas:** Connect the wireless antennas to the router
4. **Power Supply:** Connect the power adapter to the Vigor 2763's **PWR** socket on the rear and plug the power adapter into a suitable mains socket.
5. Turn the Vigor2763ac on using its power switch.

The router will start up. After completing the system test, the **ACT** LED will light up and start blinking once per second to indicate that it is ready for use.

For more detailed information of LED status, please refer to section 2 Panel Explanation.

3.2 Wall-Mounting the Vigor Router

DrayTek Vigor2763 series routers have keyhole type mounting slots on the underside to hang the router on, using screws attached to a wall or other surface.

1. Drill two holes on the wall. The distance between the holes shall be 168mm.
2. Fit screws into the wall using the appropriate type of wall plug.
3. With the screws installed, the router can be slotted into place.

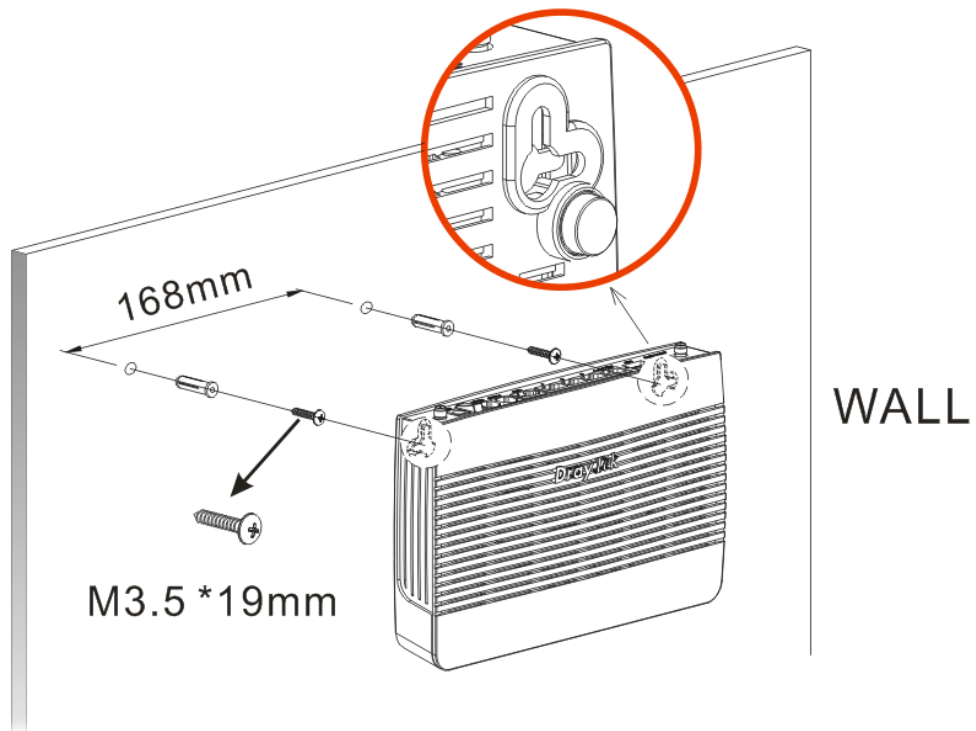

Note

The recommended drill diameter is 6.5mm (1/4").

4. Setup & Configuration

This section provides examples of how to initially access the router and configure internet access for the most common types of Internet connection.

If the instructions in this quick start guide do not allow you to get online with your ISP or type of Internet connection, contact your dealer for advanced information.



Note

To access the router, your PC will need to either get its IP address using DHCP or have an IP address in the 192.168.1.x range.

For details on how to change this, please refer to the “Trouble Shooting” section in the User Guide.

4.1 Accessing the Router Web Interface

Open a web browser on your PC and type `https://192.168.1.1`.

The `https://` prefix ensures that your connection is encrypted using SSL so that your session data cannot be intercepted. Without that prefix, your data passes in clear text.

You may get a warning from your browser (IE, Chrome, Edge, Safari etc.) about your server (the router) having an invalid certificate. Your browser will demand further confirmation or exception before allowing access. The warnings will look something like these examples.

An example of how to access the router via HTTPS with Mozilla Firefox:

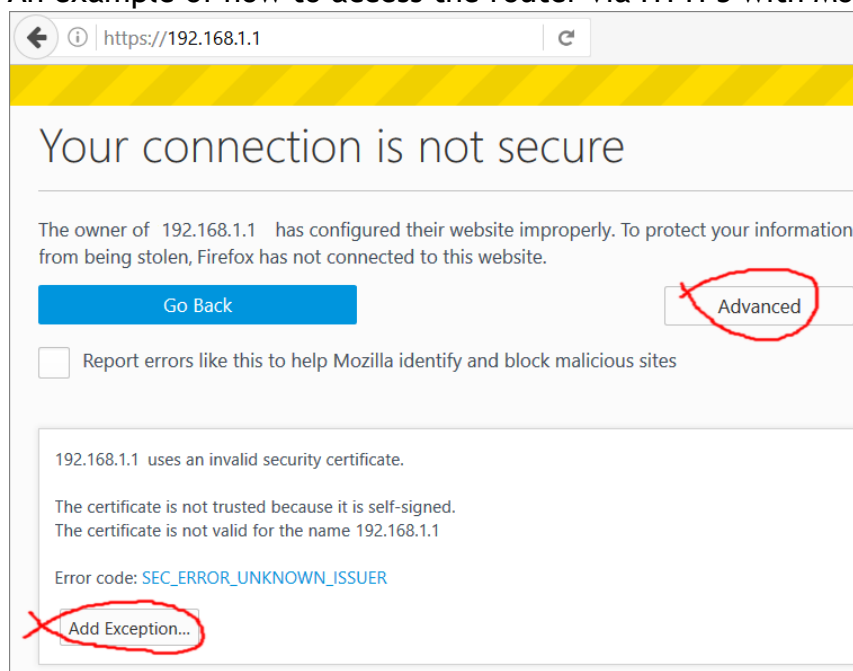

An example from Microsoft Edge, click “Continue to this webpage” to proceed:

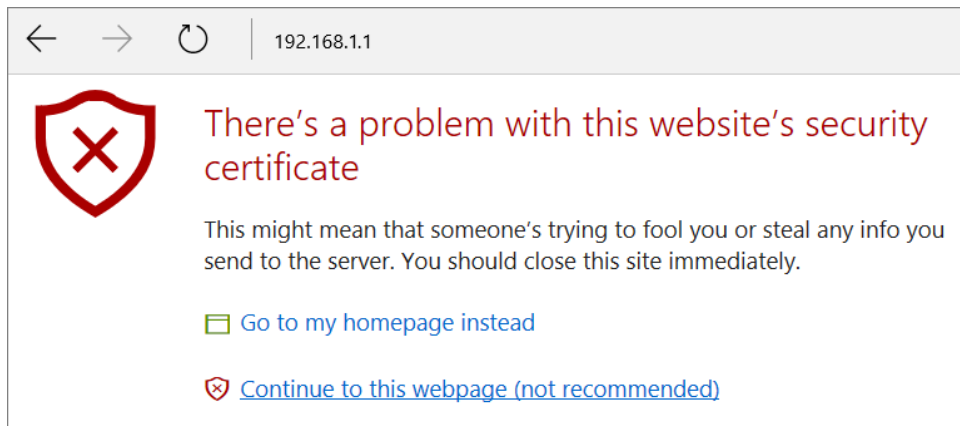

Most other browsers will present equivalent warnings. In each case, following the prompts/links will allow you to access the router's web interface. It is still encrypted with SSL/TLS.



Note

This warning appears because the router's default certificate is 'self-signed' rather than issued to you by a certificate authority who has verified your identity.

A self-signed certificate means that you cannot verify the identity of the server, but as it's your own local router, that shouldn't be an issue - your connection is still encrypted.

The router login prompt will then request a username and password to allow access.



The factory default login details are:

Username: admin
Password: admin



Note

If you cannot access the web interface, please go to the “Trouble Shooting” section in the User Guide to determine the cause of and solve your problem.

Upon successful login, the router will display the **Dashboard**, which shows a summary of the router model, WAN status, front panel port status and other information:

DrayTek Vigor2763 Series

Dashboard

Auto Logout IP6

Dashboard
Wizards
Online Status

Search Menu

WAN
LAN
Hotspot Web Portal
Routing
NAT
Hardware Acceleration
Firewall
User Management
Objects Setting
CSM
Bandwidth Management
Applications
VPN and Remote Access
Certificate Management
VoIP
Mesh
Wireless LAN (2.4 GHz)
Wireless LAN (5 GHz)
USB Application
System Maintenance
Diagnostics

Central Management
AP
External Devices

MyVigor Services
Product Registration
Service Status

All Rights Reserved.

Admin mode
Status: Ready

Dashboard

Factory Reset
WPS
USB
P4 P3 P2 P1
DSL
Phone2 Phone1

10/100M 1G

System Information

Model Name	Vigor2763Vac	System Uptime	00:01:24
Router Name	DrayTek	Current Time	Sat Jan 01 2000 00:01:16
Firmware Version	4.4.3.2_STD	Build Date/Time	Mar 4 2024 17:35:46
DSL Version	07-07-0B-05-00-07	LAN MAC Address	14-49-BC-28-05-A8

IPv4 LAN Information

LAN	IP Address	DHCP	LAN	IP Address	DHCP
LAN1	192.168.1.1/24	v	LAN2	192.168.2.1/24	v
LAN3	192.168.3.1/24	v	LAN4	192.168.4.1/24	v
IP Routed Subnet	192.168.0.1/24	v			

IPv4 Internet Access

Line / Mode	IP Address	MAC Address	Up Time
WAN1 VDSL2 / PPPoE	Disconnected	14-49-BC-28-05-A9	00:00:00
WAN3 USB / ---	Disconnected	14-49-BC-28-05-AB	00:00:00

Interface

Interface	Status	Down Stream	Up Stream
DSL	Connected	0Kbps	0Kbps
WAN	Connected	0	0
LAN	Connected	0	0
WLAN2.4G	Connected	0	0
WLAN5G	Connected	0	0
USB	Connected	0	0

Security

VPN	Connected:	0	Remote Dial-in User / LAN to LAN
MyVigor	Activate:	0	
DoS	Attack Detected:		

Quick Access

- System Status
- Firmware Upgrade
- Dynamic DNS
- TR-069
- User Management
- IMP2P Block
- Schedule
- SysLog / Mail Alert
- RADIUS
- Firewall Object Setting
- Data Flow Monitor

Certificate Status

- Expired(0)
- Expire within 30 days(0)
- Unsecure(0)
- OK(0)
- Not Valid Yet(0)

[View More](#)



Note

We recommend configuring a secure password when first logging in to the router’s administration interface.

The router’s administration password can be changed from **[System Maintenance] > [Administrator Password]**

4.2 WAN1 – ADSL & VDSL Connection Setup

The WAN1 interface of the Vigor2763 router can connect to VDSL2 and ADSL2+ lines.

If your Internet connection uses VDSL2 and your ISP has supplied you with a Username and Password to connect to the Internet, go to section

4.2.1 PPPoE connection with FTTC VDSL2

If your Internet connection uses VDSL2 and your ISP does not supply or require a Username and Password to connect to the Internet, go to section

4.2.2 DHCP / Static IP connection with FTTC VDSL2

If your Internet connection uses ADSL or ADSL2+ and your ISP has supplied you with a Username and Password to connect to the Internet, go to section

4.2.3 PPPoA connection with ADSL / ADSL2+

4.2.1 PPPoE connection with FTTC VDSL2

1. Go to [WAN] > [General Setup] and click on the WAN1 link:

WAN >> General Setup

Index	Enable	Physical Mode/Type	Active Mode
<u>WAN1</u>	<input checked="" type="checkbox"/>	VDSL2/-	Always On
<u>WAN2</u>	<input checked="" type="checkbox"/>	Ethernet/Auto negotiation	Failover
<u>WAN3</u>	<input checked="" type="checkbox"/>	USB/-	Failover

Note:

When WAN2 is enabled, LAN P4 port will be used as WAN2.

2. On the settings page:

- Set the Enable option to Yes to activate the WAN1 connection
- Set the Active Mode to Always On
- **Enable the Service - VLAN Tag insertion**
- Set the **Tag value** setting to **101**



Note

The VLAN tag value of 101(UK only) is required to connect to ISPs that operate on the Openreach VDSL2 network, if your ISP operates on a different VDSL2 network, this tag value may differ.

Please check with your ISP.

WAN >> General Setup

WAN 1

Enable:	Yes ▾	
Display Name:	<input type="text"/>	
Physical Mode:	VDSL2	
DSL Mode:	Auto ▾	
DSL Modem Code:	AnnexA_77B507_775401 ▾	
Active Mode:	Failover ▾ <input checked="" type="radio"/> WAN Failure <input type="radio"/> Traffic Threshold	
Upload:	User defined ▾ <input type="text" value="0K"/> bps (Default unit: K)	
Download:	User defined ▾ <input type="text" value="0K"/> bps (Default unit: K)	
VLAN Tag insertion	Customer (TPID 0x8100)	Service (TPID 0x8100)
ADSL	Disable ▾ Tag value <input type="text" value="0"/> Priority <input type="text" value="0"/> (0~4095) (0~7)	
VDSL2	Disable ▾ Tag value <input type="text" value="0"/> Priority <input type="text" value="0"/> (0~4095) (0~7)	Enable ▾ Tag value <input type="text" value="101"/> Priority <input type="text" value="0"/> (0~4095) (0~7)

Click **OK** on that page to apply the changes.

3. Go to **[WAN] > [Internet Access]**

Set the **WAN1 Access Mode** to **PPPoE / PPPoA**, then click the **Details Page** button to proceed:

WAN >> Internet Access

Index	Display Name	Physical Mode	Access Mode	
WAN1		ADSL / VDSL2	PPPoE / PPPoA ▾	Details Page IPv6
WAN2		Ethernet	Static or Dynamic IP ▾	Details Page IPv6
WAN3		USB	None ▾	Details Page IPv6

4. On the **PPPoE / PPPoA** settings tab:

Select the **Enable** radio button at the top of the page to ensure that the **PPPoE** interface is enabled.

In the **ISP Access Setup** section, input the ISP username into the **Username** field and password in the **Password** field.

If your ISP has provided a static IP address, that can be specified by setting the **Fixed IP** setting to **Yes** and entering the IP in the **Fixed IP Address** field.

WAN 1

PPPoE / PPPoA	MPoA / Static or Dynamic IP	IPv6
<input checked="" type="radio"/> Enable <input type="radio"/> Disable		
ADSL Modem Settings Multi-PVC channel: Channel 1 VPI: 0 VCI: 33 Encapsulating Type: LLC/SNAP Protocol: PPPoE Modulation: Multimode		
PPPoE Pass-through <input type="checkbox"/> For Wired LAN ² <input type="checkbox"/> For Wireless LAN		
WAN Connection Detection Mode: PPP Detect		
MTU Path MTU Discovery: Detect (Max:1500)		
ISP Access Setup Service Name ¹ : Max: 23 characters Username: 123456@HG01.btclick.com Password: ***** <input type="checkbox"/> Separate Account for ADSL PPP Authentication: PAP/CHAP/MS-CHAP/MS-CHAPv2 IP Address From ISP: WAN IP Alias Fixed IP: <input type="radio"/> Yes <input checked="" type="radio"/> No (Dynamic IP) Fixed IP Address: <input type="text"/> <input checked="" type="radio"/> Default MAC Address <input type="radio"/> Specify a MAC Address MAC Address: 14 · 49 · BC · 28 · 05 · A9 Index(1-15) in Schedule Setup: => 0, 0, 0, 0		

Click **OK** on this page to apply the changes and the router will then prompt to restart. Click the OK button to restart the router.

- Once the router has restarted, the **[Online Status] > [Physical Connection]** page will display the VDSL information and PPP connection status, if the WAN1 section shows an IP address, it has connected to the internet successfully:

Online Status

Physical Connection		System Uptime: 0:8:44			
IPv4		IPv6			
LAN Status	Primary DNS: 194.72.0.98		Secondary DNS: 213.120.234.26		
IP Address	TX Packets	RX Packets			
192.168.1.1	0	0			
WAN 1 Status >> Drop PPPoA					
Enable	Line	Name	Mode	Up Time	
Yes	VDSL2		PPPoE	0:07:41	
IP	GW IP	TX Packets	TX Rate(Bps)	RX Packets	RX Rate(Bps)
217.34.6.35	217.42.145.215	224580	805	339568	963
WAN 2 Status					
Enable	Line	Name	Mode	Up Time	
Yes	Ethernet		---	00:00:00	
IP	GW IP	TX Packets	TX Rate(Bps)	RX Packets	RX Rate(Bps)
---	---	0	0	0	0
WAN 3 Status					
Enable	Line	Name	Mode	Up Time	Signal
Yes	USB		---	00:00:00	-
IP	GW IP	TX Packets	TX Rate(Bps)	RX Packets	RX Rate(Bps)
---	---	0	0	0	0
VDSL2 Information (VDSL2 Firmware Version: 8B0F07_A/B/C)					
Profile	State	UP Speed	Down Speed	SNR Upstream	SNR Downstream
17A	SHOWTIME	20000 (Kbps)	80000 (Kbps)	15 (0.1dB)	6 (0.1dB)



Note

If the WAN 1 IP address displayed begins with 172.16.x.x, it's possible that the ISP has not accepted the supplied Username and Password for the Internet connection.

Check that the ISP Access Setup - Username and Password match the details supplied by your ISP.

4.2.2 DHCP / Static IP connection with FTTC VDSL2

1. Go to [WAN] > [General Setup] and click on the WAN1 link:

WAN >> General Setup

Index	Enable	Physical Mode/Type	Active Mode
<u>WAN1</u>	<input checked="" type="checkbox"/>	VDSL2/-	Always On
<u>WAN2</u>	<input checked="" type="checkbox"/>	Ethernet/Auto negotiation	Failover
<u>WAN3</u>	<input checked="" type="checkbox"/>	USB/-	Failover

Note:

When WAN2 is enabled, LAN P4 port will be used as WAN2.

OK

Cancel

2. On the settings page:

- Set the Enable option to Yes to activate the WAN1 connection
- Set the Active Mode to Always On
- **Enable the Service - VLAN Tag insertion**
- Set the **Tag value** setting to **101**



Note

The VLAN tag value of 101(UK only) is required to connect to ISPs that operate on the Openreach VDSL2 network, if your ISP operates on a different VDSL2 network, this tag value may differ.

Please check with your ISP.

WAN >> General Setup

WAN 1

Enable:	Yes ▾	
Display Name:	<input type="text"/>	
Physical Mode:	VDSL2	
DSL Mode:	Auto ▾	
DSL Modem Code:	AnnexA_77B507_775401 ▾	
Active Mode:	Failover ▾	
	<input checked="" type="radio"/> WAN Failure <input type="radio"/> Traffic Threshold	
Upload	User defined ▾	0K bps (Default unit: K)
Download	User defined ▾	0K bps (Default unit: K)
VLAN Tag insertion	Customer (TPID 0x8100)	Service (TPID 0x8100)
ADSL	Disable ▾ Tag value Priority <input type="text"/> <input type="text"/> (0~4095) (0~7)	
VDSL2	Disable ▾ Tag value Priority <input type="text"/> <input type="text"/> (0~4095) (0~7)	Enable ▾ Tag value Priority <input type="text"/> <input type="text"/> (0~4095) (0~7)

Click **OK** on that page to apply the changes.

- Go to [WAN] > [Internet Access]

Set the **WAN1 Access Mode** to **MPoA / Static or Dynamic IP**, then click the **Details Page** button to proceed:

WAN >> Internet Access

Internet Access

Index	Display Name	Physical Mode	1	Access Mode	2
WAN1		ADSL / VDSL2		MPoA / Static or Dynamic IP ▾	Details Page IPv6
WAN2		Ethernet		Static or Dynamic IP ▾	Details Page IPv6
WAN3		USB		None ▾	Details Page IPv6

DHCP Client Option

- In the MPoA / Static or Dynamic IP settings:

Select the **Enable** option and select **Obtain an IP address automatically** which will obtain an IP from the ISP using DHCP.

If your ISP has provided a static IP range, with a Network address and a Subnet Mask, specify that with the **Specify an IP address** option.

WAN 1

PPPoE / PPPoA **MPoA / Static or Dynamic IP** **IPv6**

Enable Disable

ADSL Modem Settings

Multi-PVC channel:

Encapsulation:

VPI:

VCI:

Modulation:

WAN Connection Detection

Mode:

MTU (Max:1500)

Path MTU Discovery:

WAN IP Network Settings

Obtain an IP address automatically

Router Name:

Domain Name:

DHCP Client Identifier *

Username:

Password:

Specify an IP address

IP Address:

Subnet Mask:

Gateway IP Address:

Click **OK** on this page to apply the changes and the router will then prompt to restart. Click the OK button to restart the router.

- Once the router has restarted, the **[Online Status] > [Physical Connection]** page will display the VDSL information and DHCP connection status, if the WAN1 section shows an IP address, it has connected to the internet successfully:

Online Status

Physical Connection		System Uptime: 0:8:44			
IPv4		IPv6			
LAN Status	Primary DNS: 194.72.0.98		Secondary DNS: 213.120.234.26		
IP Address	TX Packets	RX Packets			
192.168.1.1	0	0			
WAN 1 Status >> Drop PPPoA					
Enable	Line	Name	Mode	Up Time	
Yes	VDSL2		PPPoE	0:07:41	
IP	GW IP	TX Packets	TX Rate(Bps)	RX Packets	RX Rate(Bps)
217.34.6.35	217.42.145.215	224580	805	339568	963
WAN 2 Status					
Enable	Line	Name	Mode	Up Time	
Yes	Ethernet		---	00:00:00	
IP	GW IP	TX Packets	TX Rate(Bps)	RX Packets	RX Rate(Bps)
---	---	0	0	0	0
WAN 3 Status					
Enable	Line	Name	Mode	Up Time	Signal
Yes	USB		---	00:00:00	-
IP	GW IP	TX Packets	TX Rate(Bps)	RX Packets	RX Rate(Bps)
---	---	0	0	0	0
VDSL2 Information (VDSL2 Firmware Version: 8B0F07_A/B/C)					
Profile	State	UP Speed	Down Speed	SNR Upstream	SNR Downstream
17A	SHOWTIME	20000 (Kbps)	80000 (Kbps)	15 (0.1dB)	6 (0.1dB)

4.2.3 PPPoA connection with ADSL / ADSL2+

1. Go to [WAN] > [Internet Access]

Set the **WAN1 Access Mode** to PPPoE / PPPoA and click the **Details Page** button to proceed:

WAN >> Internet Access

Internet Access					
Index	Display Name	Physical Mode	Access Mode		
WAN1		ADSL / VDSL2	PPPoE / PPPoA	Details Page	IPv6
WAN2		Ethernet	Static or Dynamic IP	Details Page	IPv6
WAN3		USB	None	Details Page	IPv6

DHCP Client Option

2. On the PPPoE / PPPoA settings tab:

The details for the **VPI** and **VCI** settings for ADSL should be correct for UK usage, with **0** and **38** being the defaults. In most cases, it will not be necessary to change these.

The **Modulation** setting can be left on its default of Multimode which will auto-detect the correct ADSL type to use.

WAN >> Internet Access

WAN 1

PPPoE / PPPoA	MPoA / Static or Dynamic IP	IPv6
<input checked="" type="radio"/> Enable <input type="radio"/> Disable		
ADSL Modem Settings		
Multi-PVC channel	Channel 1	
VPI	0	
VCI	38	
Encapsulating Type	LLC/SNAP	
Protocol	PPPoE	
Modulation	Multimode	
PPPoE Pass-through		
<input type="checkbox"/> For Wired LAN ²		
<input type="checkbox"/> For Wireless LAN		
WAN Connection Detection		
ISP Access Setup		
Service Name ¹	Max: 23 characters	
Username	123456@HG01.btclick.com	
Password	*****	
<input type="checkbox"/> Separate Account for ADSL		
PPP Authentication	PAP/CHAP/MS-CHAP/MS-CHAPv2	
IP Address From ISP	WAN IP Alias	
Fixed IP	<input type="radio"/> Yes <input checked="" type="radio"/> No (Dynamic IP)	
Fixed IP Address		
<input checked="" type="radio"/> Default MAC Address		
<input type="radio"/> Specify a MAC Address		
MAC Address: [14] [48] [8C] [38] [05] [A9]		

Select the **Enable** radio button at the top of the page to ensure that the PPPoA interface is enabled.

Enter the ISP credentials into the **Username** and **Password** fields.

If your ISP has provided a static IP address, that can be specified by setting the **Fixed IP** setting to **Yes** and entering the IP in the **Fixed IP Address** field. Click **OK** on this page to apply the changes and the router will then prompt to restart. Click the OK button to restart the router.

- Once the router has restarted, the **[Online Status] > [Physical Connection]** page will display the ADSL information and PPP connection status, if the WAN1 section shows an IP address, it has connected to the internet successfully:

Online Status

Physical Connection						System Uptime: 0:8:44
IPv4			IPv6			
LAN Status		Primary DNS: 194.72.0.98		Secondary DNS: 213.120.234.26		
IP Address	TX Packets	RX Packets				
192.168.1.1	0	0				
WAN 1 Status >> Drop PPPoA						
Enable	Line	Name	Mode	Up Time		
Yes	VDSL2		PPPoE	0:07:41		
IP	GW IP	TX Packets	TX Rate(Bps)	RX Packets	RX Rate(Bps)	
217.34.6.35	217.42.145.215	224580	805	339568	963	
WAN 2 Status						
Enable	Line	Name	Mode	Up Time		
Yes	Ethernet		---	00:00:00		
IP	GW IP	TX Packets	TX Rate(Bps)	RX Packets	RX Rate(Bps)	
---	---	0	0	0	0	
WAN 3 Status						
Enable	Line	Name	Mode	Up Time	Signal	
Yes	USB		---	00:00:00	-	
IP	GW IP	TX Packets	TX Rate(Bps)	RX Packets	RX Rate(Bps)	
---	---	0	0	0	0	
VDSL2 Information (VDSL2 Firmware Version: 8B0F07_A/B/C)						
Profile	State	UP Speed	Down Speed	SNR Upstream	SNR Downstream	
17A	SHOWTIME	20000 (Kbps)	80000 (Kbps)	15 (0.1dB)	6 (0.1dB)	



Note

If the WAN 1 IP address displayed begins with 172.16.x.x, it's possible that the ISP has not accepted the supplied Username and Password for the Internet connection.

Check that the ISP Access Setup - Username and Password match the details supplied by your ISP.

5. Getting Further Help

If the router does not appear to be operating correctly or you cannot get online to the Internet, please visit our web site for further troubleshooting advice or to contact our support technicians. Always have your serial number to hand.

For warranty service, in the first instance, please contact the support services, as listed above, for help in diagnosing or eliminating the problem or issue. The support department can arrange repair or service if then deemed necessary.

You should keep your proof of purchase (original invoice) safely in case warranty or other service is ever required.

5.1 Additional Feature Setup

This is a quick setup guide to get you online with your new router. Your Vigor2763 series router is capable of very much more and has a plethora of other features.

These are covered in the main user manual.

5.2 Keep up to date with our mailing list

Now that you have your DrayTek product, you should keep up to date with product updates (firmware), security advisories and other product news, advice or special offers.

In other countries or regions, please contact your local distributor/supplier for local options.

5.3 Firmware Updates

It is strongly recommended that you keep your router firmware up to date with the latest version in order to have all of the latest security and feature improvements.

Always obtain firmware from official sources.

There are two firmware file types:

.all - upgrade4 retaining all previous settings

.rst - upgrade and reset to factory default

It is recommended to take a configuration backup prior to upgrading the firmware.